

Stratos[®] Pro A2... MSPH

Instruction Manual

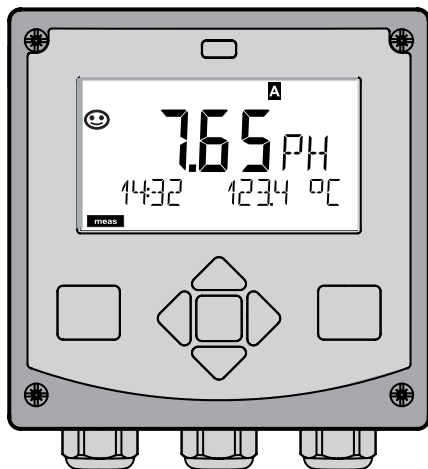

Latest Product Information:

www.knick.de



77184

Knick >

Warranty

Warranty

Defects occurring within 3 years from delivery date shall be remedied free of charge at our plant (carriage and insurance paid by sender).
Sensors, fittings, and accessories: 1 year.

Subject to change without notice.

Return of Products Under Warranty

Please contact our Service Team before returning a defective device. Ship the cleaned device to the address you have been given. If the device has been in contact with process fluids, it must be decontaminated/disinfected before shipment. In that case, please attach a corresponding certificate, for the health and safety of our service personnel.

Disposal

Please observe the applicable local or national regulations concerning the disposal of “waste electrical and electronic equipment”.



CD-ROM

Complete documentation:

- Instruction manuals
- Safety instructions
- Short instructions



Safety Information

In official EU languages and others.

- ATEX / IECEX / FM / CSA
- EC Declarations of Conformity



Short Instructions

In German, English, French, Russian, Spanish, Portuguese, Swedish, and Dutch. More languages on CD-ROM and on our website: www.knick.de

- Installation and commissioning
- Operation
- Menu structure
- Calibration
- Error messages and recommended actions

Specific Test Report

Contents

Documents Supplied	3
Introduction	7
Intended Use.....	7
Safety Information	8
Overview of Stratos Pro A2... MSPH.....	10
Assembly	11
Package Contents.....	11
Mounting Plan, Dimensions.....	12
Pipe Mounting, Protective Hood.....	13
Panel Mounting.....	14
Installation	15
Installation Instructions	15
Rating Plates / Terminal Assignments.....	16
Wiring of Stratos Pro A201/211 MSPH.....	17
Wiring Examples	19
User Interface, Keypad	22
Display	23
Signal Colors (Display Backlighting).....	23
Measuring Mode.....	24
Selecting the Mode / Entering Values	25
Operating Modes.....	26
Menu Structure of Modes and Functions.....	27
HOLD Mode.....	28
Alarm.....	29
Configuration	30
Menu Structure of Configuration	30
Parameter Set A/B	32
Configuration (Original for Copy).....	36
Sensor	38
Current Output 1	46
Current Output 2	52

Temperature Compensation	54
Alarm.....	56
Time and Date	58
Tag Number	58
Digital Sensors	60
Operation	60
Connecting a Digital Sensor.....	61
Sensor Replacement	62
Calibration	64
Selecting a Calibration Mode	65
Zero Adjustment (ISFET).....	66
Automatic Calibration (Calimatic)	68
Manual Calibration with Buffer Entry	70
Data Entry of Premeasured Sensors	72
Product Calibration (pH).....	74
ORP (Redox) Calibration	76
Temp Probe Adjustment.....	78
Measurement	79
Diagnostics	80
Service	85
Operating States.....	88
Product Line and Accessories	89
A201/A211X: Supply Units and Connection	90
Specifications	91
Buffer Tables	97
-U1- Specifiable Buffer Set	106
Error Handling.....	109
Error Messages.....	110
Sensoface	113

Contents

EC Declaration of Conformity	116
Stratos Pro A2...X MSPH: Control Drawing	118
FM Control Drawing.....	119
CSA Control Drawing.....	120
FDA 21 CFR Part 11	121
Electronic Signature – Passcodes	121
Audit Trail	121
Index	122
Trademarks	131
Passcodes	132

Intended Use

The Stratos Pro A2... MSPH is used for pH/mV, ORP, and temperature measurement in industry, environment, food processing, and sewage treatment.

The sturdy molded enclosure can be fixed into a control panel or mounted on a wall or at a post. The protective hood, which is available as accessory, provides additional protection against direct weather exposure and mechanical damage.

The device has been designed for digital sensors.

Plain-text messages in a large, backlit display allow intuitive operation. The colored display backlighting signals alarm messages (red) or HOLD mode (orange).

The "Sensocheck" automatic monitoring of glass and reference electrode and the "Sensoface" function for clear indication of the sensor condition provide excellent diagnostics. The internal logbook can handle up to 100 entries – up to 200 with AuditTrail (TAN).

The device provides two parameter sets which can be switched manually or via a control input for different process adaptations or different process conditions (e.g. beer and CIP).

Password protection for granting access rights during operation can be configured.

Two floating, digital control inputs ("Hold" and "Control") are available for external control.

The device provides two current outputs (for transmission of measured value and temperature, for example).

Approvals for Measurement in Hazardous Locations:

Stratos Pro A201/A211N MSPH: General Safety.

Stratos Pro A201/A211X MSPH: Approved for operation in hazardous locations according to IECEx / ATEX / FM / CSA.

Safety Information

Safety information –

Be sure to read and observe the following instructions!

The device has been manufactured using state of the art technology and it complies with applicable safety regulations.

When operating the device, certain conditions may nevertheless lead to danger for the operator or damage to the device.

See also separate document:

- “Safety Instructions”
(EC Declaration of Conformity, FM, CSA, ATEX (if applicable)
Certificates)

CAUTION!

Commissioning must only be performed by trained personnel authorized by the operating company! Whenever it is likely that protection has been impaired, the device shall be made inoperative and secured against unintended operation.

The protection is likely to be impaired if, for example:

- the device shows visible damage
- the device fails to perform the intended measurements
- after prolonged storage at temperatures above 70°C
- after severe transport stresses

Before recommissioning the device, a professional routine test must be performed. This test must be carried out at the manufacturer's factory.

Please note:

Before commissioning it must be proved that the device may be connected with other equipment.

Information for Installation in Hazardous Locations (Stratos Pro A201/A211X MSPH)

- Be sure to observe the stipulations of EN 60079-10 / EN 60079-14 or the corresponding local regulations during installation and commissioning. See also separate “Safety Instructions” document.

Approvals for application in hazardous locations (Stratos Pro A201/A211X MSPH)

- according to IECEx in Zone 0, 1, 20, 21
- according to ATEX in Zone 0, 1, 2, 20, 21
- according to cCSAus in Class I Div 1, 2 / Zone 1
- according to FM in Class I, Div 1, 2 / Zone 1



Important Notice:

The operator must indicate the type of protection!

When the device provides different types of protection, the operator must specify the applied type of protection during installation.

To do so, use the checkboxes on the rating plate:

Knick >	PH	KEMA 08 ATEX 0100	IECEx KEM 08.0020
A2...X-...	<input type="checkbox"/> II 2(1) G Ex ib [ia] IIC T4/ <input type="checkbox"/> I G Ex ia IIC T4	<input checked="" type="checkbox"/> Ex ib [ia] IIC T4/ Zone 0 Ex ia IIC T4	
No. 12345 / 1234567 / 0832	<input type="checkbox"/> II 1 D Ex iaD 20 IP6x T85°C/ <input type="checkbox"/> II 2 D Ex iaD 21 IP6x T85°C	<input type="checkbox"/> Ex iaD 20 IP6x T85°C	
-20 ≤ T _a ≤ +65°C			
	Electrical data see Control drawing 212.002-100		
D-14163Befin Made in Germany			0044

Stratos Pro A2...X rating plate at outside bottom of front with checkboxes for marking the respective application after installation

Terminals:

Screw terminal, suitable for single wires / flexible leads up to 2.5 mm² (AWG 14). Recommended torque for the terminal screws: 0.5 ... 0.6 Nm.

Overview

Overview of Stratos Pro A2... MSPH

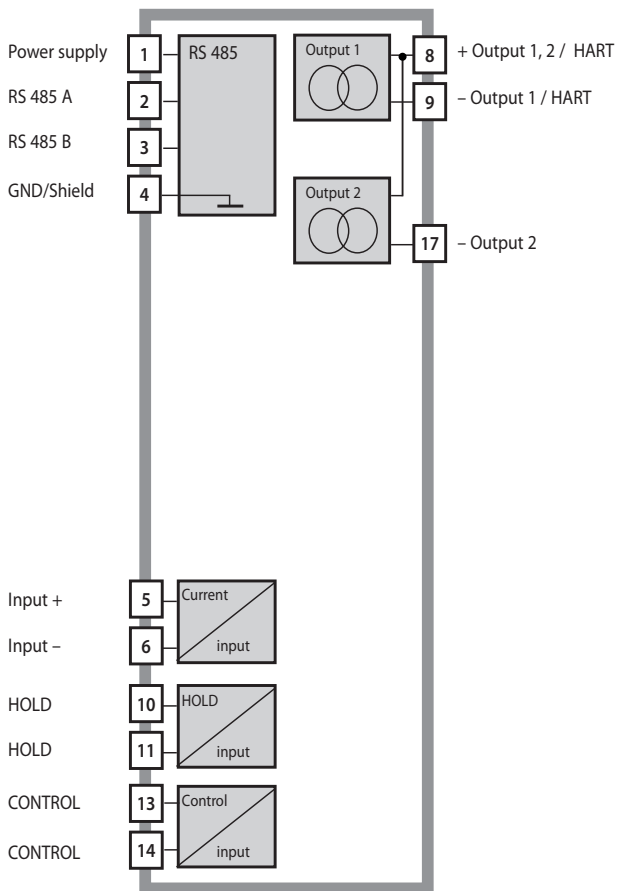

Package Contents

Check the shipment for transport damage and completeness!

The package should contain:

- Front unit, rear unit, bag containing small parts
- Specific test report
- Documentation (cf Pg 3)
- CD-ROM

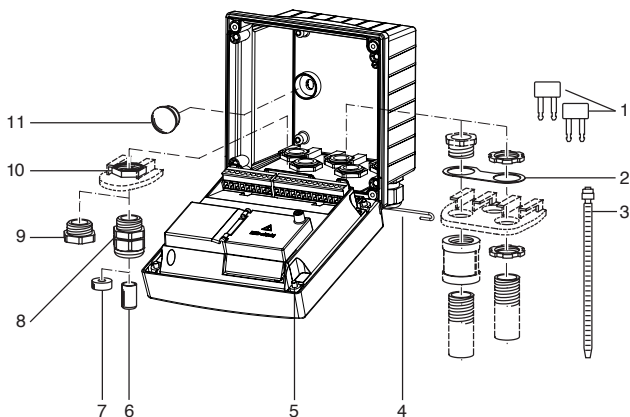

Fig.: Assembling the enclosure

- | | |
|---|--|
| 1) Jumper (3 x) | 6) Sealing insert (1 x) |
| 2) Washer (1 x), for conduit mounting: Place washer between enclosure and nut | 7) Rubber reducer (1 x) |
| 3) Cable tie (3 x) | 8) Cable gland (3 x) |
| 4) Hinge pin (1 x), insertable from either side | 9) Filler plug (3 x) |
| 5) Enclosure screw (4 x) | 10) Hexagon nut (5 x) |
| | 11) Sealing plug (2 x), for sealing in case of wall mounting |

Mounting Plan, Dimensions

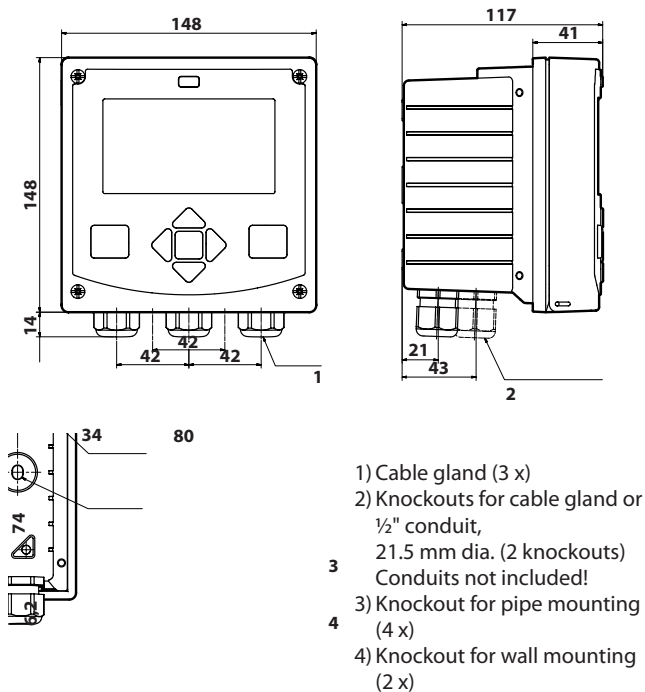
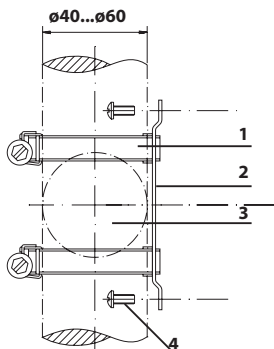

Fig.: Mounting plan (All dimensions in mm!)

Pipe Mounting, Protective Hood



- 1) Hose clamp with worm gear drive to DIN 3017 (2 x)
- 2) Pipe-mount plate (1 x)
- 3) For vertical or horizontal posts or pipes
- 4) Self-tapping screw (4 x)

Fig.: ZU 0274 pipe-mount kit (All dimensions in mm!)

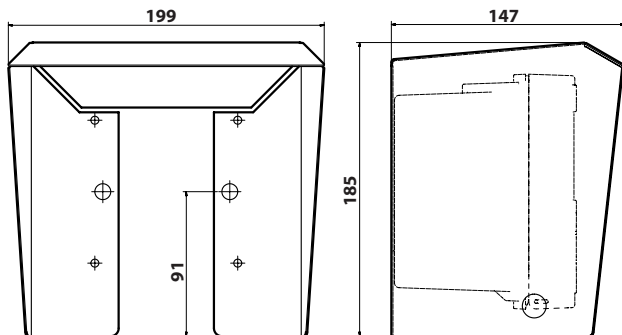

Fig.: ZU 0737 protective hood for wall and pipe mounting
(All dimensions in mm!)

Panel Mounting

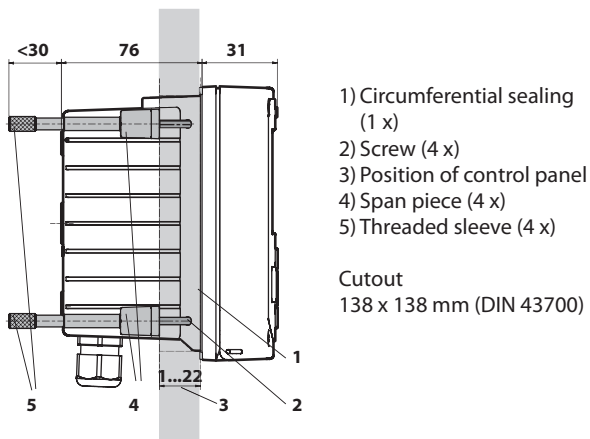

Fig.: ZU 0738 panel-mount kit (All dimensions in mm!)

Installation Instructions

- Installation of the device must be carried out by trained experts in accordance with this instruction manual and as per applicable local and national codes.
- Be sure to observe the technical specifications and input ratings during installation!
- Be sure not to notch the conductor when stripping the insulation!
- The supplied current must be galvanically isolated. If not, connect an isolator module.
- All parameters must be set by a system administrator prior to commissioning!

Terminals:

suitable for single wires / flexible leads up to 2.5 mm² (AWG 14)



Additional safety precautions have to be taken for applications in hazardous locations according to IECEx, ATEX, FM, CSA!
(See also separate "Safety Instructions" document.)

Rating Plates / Terminal Assignments

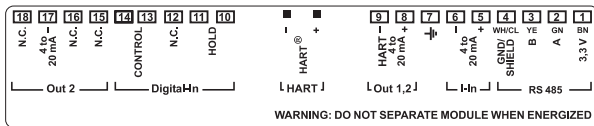

Fig.: Terminal assignments of Stratos Pro A2...

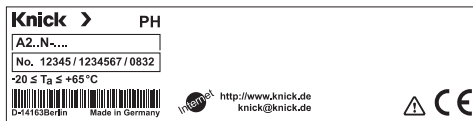

Fig.: Outer rating plate Stratos Pro A2...N at bottom of front

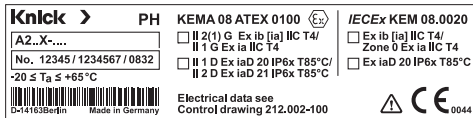

Fig.: Stratos Pro A2...X rating plate at outside bottom of front

Important Notice:

The operator must indicate the type of protection!

When the device provides different types of protection, the operator must specify the applied type of protection during installation.

To do so, use the checkboxes on the rating plate.

See also "Safety Information" chapter.

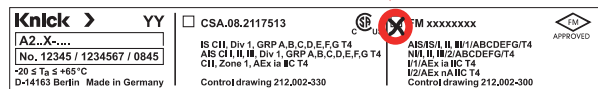
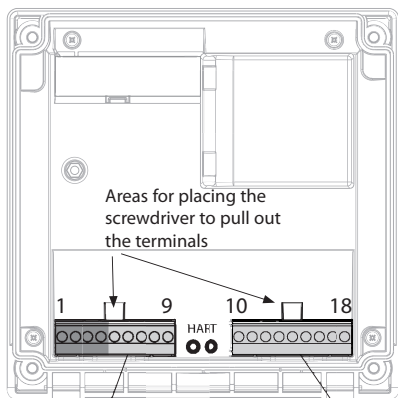

Fig.: Example of additional approval plate (cCSAus, FM)

The specifications refer to the respective device.

Wiring of Stratos Pro A201/211 MSPH



Terminal row 1	
1 (BN)	Power supply ⚠
2 (GN)	RS 485 A ⚠
3 (YE)	RS 485 B ⚠
4 (WH)	GND/shield ⚠
5	+ input
6	- input
7	PA (equip. bonding)
8	+out 1,2/HART
9	- out 1/HART

Terminal row 2	
10	hold
11	hold
12	n.c.
13	contr
14	contr
15	n.c.
16	n.c.
17	- out 2
18	n.c.

In addition:

2 HART pins (between terminal row 1 and 2

⚠ Sensor connection RS-485

Fig.: Terminals, device opened, back of front unit

Example 1:

Measuring task: pH/ORP, temp, glass impedance, ref. impedance

Sensors (example): SE 533/1-ADIN (Knick)

Cable (example): CA/003-NAADIN11 (Knick)

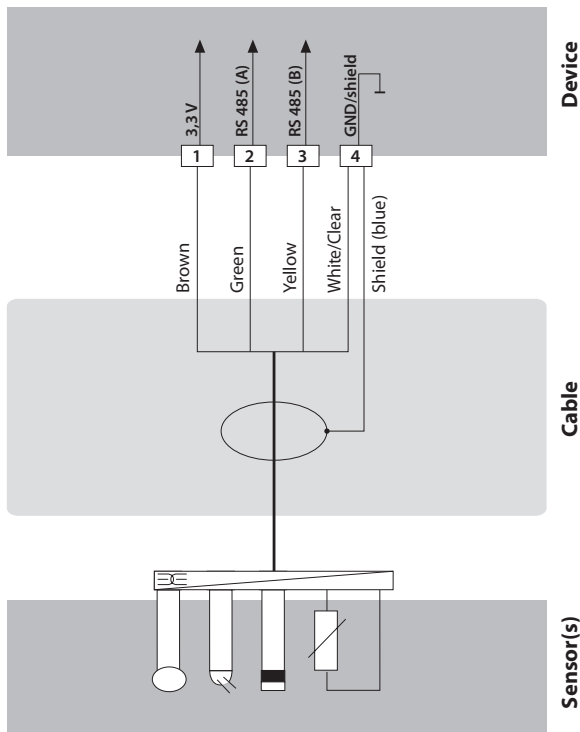

Example 2:

Measuring task: pH/ORP, temp, glass impedance

Sensors (example): SE531/1-NMSN (Knick)

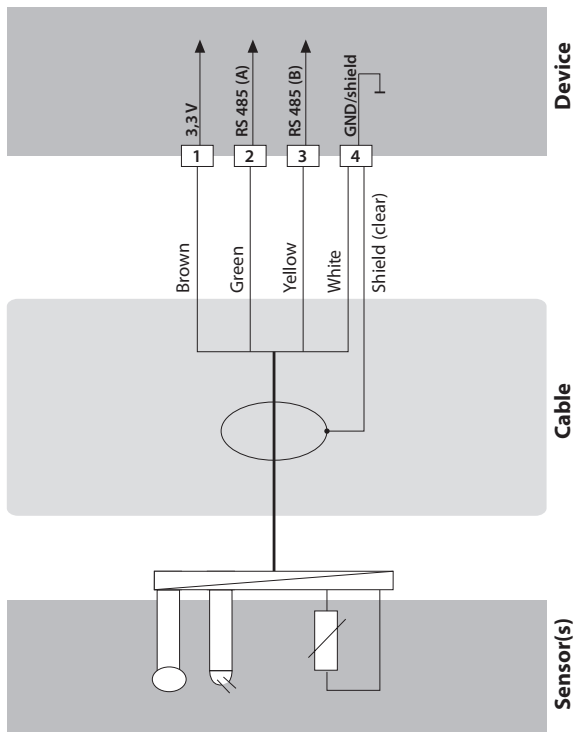

User Interface, Keypad

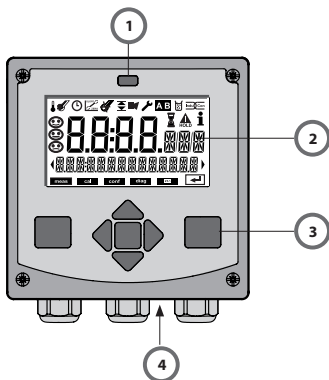

- 1 IrDA transmitter/receiver
- 2 Display
- 3 Keypad
- 4 Rating plate (bottom)

Key	Function
meas	<ul style="list-style-type: none">• Return to last menu level• Directly to measuring mode (press > 2 s)
info	<ul style="list-style-type: none">• Retrieve information• Show error messages
enter	<ul style="list-style-type: none">• Configuration: Confirm entries, next configuration step• Calibration: Continue program flow• Measuring mode: Display output current
Arrow keys up / down	<ul style="list-style-type: none">• Measuring mode: Call menu• Menu: Increase/decrease a numeral• Menu: Select
Arrow keys left / right	<ul style="list-style-type: none">• Measuring mode: Call menu• Menu: Previous/next menu group• Number entry: Move between digits

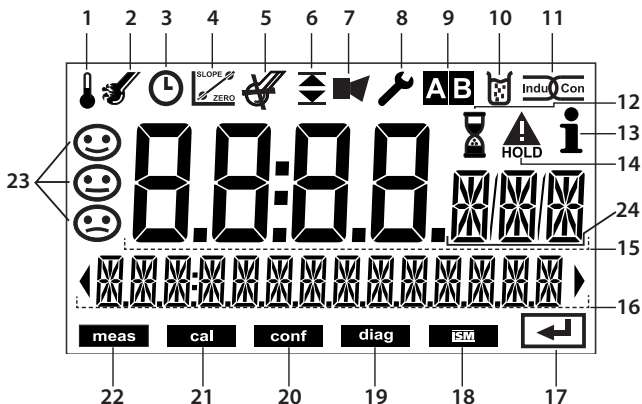

- | | |
|-----------------------------|-----------------------|
| 1 Temperature | 13 Info available |
| 2 Sensoscheck | 14 HOLD mode active |
| 3 Interval/response time | 15 Main display |
| 4 Sensor data | 16 Secondary display |
| 5 Digital sensor devaluated | 17 Proceed with enter |
| 6 Limit values | 18 Digital sensor |
| 7 Alarm | 19 Diagnostics |
| 8 Service | 20 Configuration mode |
| 9 Parameter sets A/B | 21 Calibration mode |
| 10 Calibration | 22 Measuring mode |
| 11 Digital sensor | 23 Sensoface |
| 12 Waiting time running | 24 Measurement symbol |

Signal Colors (Display Backlighting)

- | | |
|-----------|---|
| Red | Alarm |
| Orange | HOLD mode (Calibration, Configuration, Service) |
| Turquoise | Diagnostics |
| Green | Info |
| Purple | Sensoface message |

Measuring Mode

After the operating voltage has been connected, the device automatically goes to “Measuring” mode. To call the measuring mode from another operating mode (e.g. Diagnostics, Service): Hold **meas** key depressed (> 2 s).

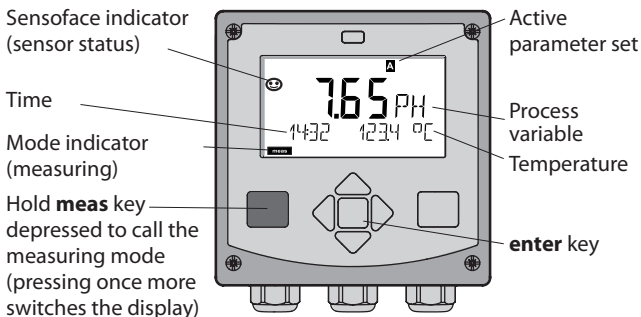

In measuring mode the display indicates:

- Measured value and time (24/12 h AM/PM) as well as temperature in °C or °F (formats selected during configuration)

By pressing the **meas** key in measuring mode you can view the following displays (for approx. 60 sec):

- Measured value and selection of parameter set A/B (if set to “Manual”)
- Measured value and tag (point of measurement designation – entered during configuration)
- Time and date

Pressing the **enter** key shows the output currents. They are displayed as long as **enter** is held depressed, then the measured-value display will return after 3 sec.



The device must be configured for the respective measurement task!

Selecting the Mode / Entering Values

To select the operating mode:

- 1) Hold **meas** key depressed (> 2 s) (measuring mode)
- 2) Press any arrow key: the selection menu appears
- 3) Select operating mode using left / right arrow key
- 4) Press **enter** to confirm the selected mode

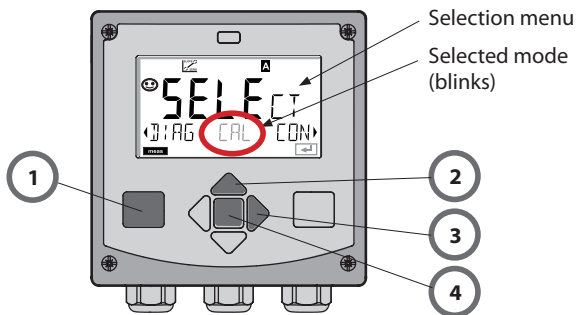

To enter a value:

- 5) Select numeral: left / right arrow key
- 6) Change numeral: up / down arrow key
- 7) Confirm entry with **enter**

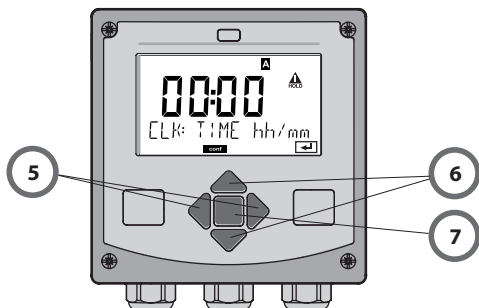

Operating Modes

Diagnostics

Display of calibration data, display of sensor data, performing a device self-test, viewing the logbook entries, display of hardware/software versions of the individual components. The logbook can store 100 events (00...99). They can be displayed directly on the device. The logbook can be extended to 200 entries using a TAN (Option).

HOLD

Manual activation of HOLD mode, e.g. for replacing a digital sensor. The signal outputs adopt a defined state.

Calibration

Every sensor has typical characteristic values, which change in the course of the operating time. Calibration is required to supply a correct measured value. The device checks which value the sensor delivers when measuring in a known solution. When there is a deviation, the device can be "adjusted". In that case, the device displays the "actual" value and internally corrects the measurement error of the sensor. Calibration must be repeated at regular intervals. The time between the calibration cycles depends on the load on the sensor. During calibration the device is in HOLD mode.

During calibration the analyzer remains in the HOLD mode until it is stopped by the operator.

Configuration

The analyzer must be configured for the respective measurement task. In the "Configuration" mode you select the connected sensor, the measurement range to be transmitted, and the conditions for warning and alarm messages. During configuration the device is in HOLD mode.

Configuration mode is automatically exited 20 minutes after the last keystroke. The device returns to measuring mode.

Service

Maintenance functions (monitor, current source), IrDA operation, passcode assignment, reset to factory settings, enabling of options (TAN).

Menu Structure of Modes and Functions

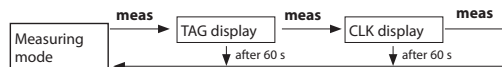

Pressing any arrow key opens the selection menu.
 Select the menu group using the left/right arrow keys.
 Press **enter** to open a menu. Press **meas** to return.

 DIAG	CALDATA SENSOR SELFTEST LOGBUCH MONITOR VERSION	Display of calibration data Display of sensor data Self test: RAM, ROM, EEPROM, module 100 events with date and time Display of measured values (mV_pH, mV_ORP, RTD, resistances of glass electrode, reference electrode) Display of software version, model designation, serial number
HOLD		Manual activation of HOLD mode, e.g. for sensor replacement. The signal outputs behave as configured (e.g. last measured value, 21 mA)
CAL	CAL_PH CAL_ORP P_CAL ISFET-ZERO CAL_RTD	pH adjustment (as configured) ORP adjustment Product calibration Zero adjustment (for ISFET only) Adjustment of temperature probe
CONF	PARSET A PARSET B	Configuring parameter set A Configuring parameter set B
SERVICE (Access via code, factory setting: 5555)	MONITOR OUT1 OUT2 IRDA CODES DEFAULT OPTION	Display of measured values for validation (simulators) Current source, output 1 Current source, output 2 Activating the IrDA interface Specifying access codes for operating modes Reset to factory setting Enabling an option via TAN

HOLD Mode

The HOLD mode is a safety state during configuration and calibration. Output current is frozen (Last) or set to a fixed value (Fix). The HOLD mode is indicated by orange display backlighting.

HOLD mode, display icon:



Output Signal Response

- **Last:** The output current is frozen at its last value. Recommended for short configuration procedures. The process should not change decisively during configuration. Changes are not noticed with this setting!
- **Fix:** The output current is set to a value that is noticeably different from the process value to signal the control system that the device is being worked at.

Output Signal During HOLD:

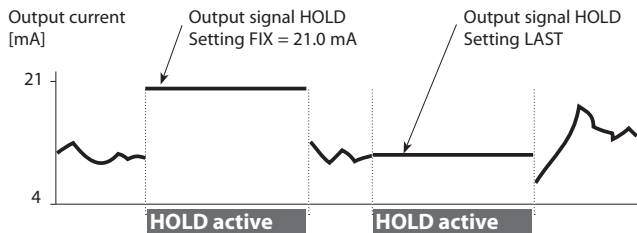

Terminating the HOLD Mode

The HOLD mode is ended by switching to measuring mode (hold **meas** key depressed). The display reads "Good Bye", after that, the HOLD mode is exited.

When the calibration mode is exited, a confirmation prompt ensures that the installation is ready for operation (e.g.: sensor reinstalled, located in process).

External Activation of HOLD

The HOLD mode can be activated from outside by sending a signal to the Hold input (e.g. from the process control system).

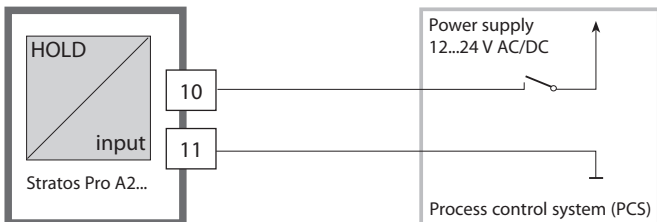

HOLD inactive	0...2 V AC/DC
HOLD active	10...30 V AC/DC

Manual Activation of HOLD

The HOLD can be activated manually from the HOLD menu. This allows checking or replacing a sensor, for example, without provoking unintended reactions of outputs or contacts. Press **meas** key to return to selection menu.

Alarm

When an error has occurred, **Err xx** is displayed immediately. Only after expiry of a user-defined delay time will the alarm be registered and entered in the logbook. During an alarm the display blinks, the display backlighting turns **red**.

Error messages can also be signaled by a 22 mA output current (see Configuration).

2 sec after the failure event is corrected, the alarm status will be deleted.

Configuration

Menu Structure of Configuration

The device provides 2 parameter sets "A" and "B". By switching between the parameter sets you can adapt the device to different measurement situations, for example.

Parameter set "B" only permits setting of process-related parameters. The configuration steps are assigned to different menu groups.

Using ◀ and ▶, you can jump between the individual menu groups. Each menu group contains menu items for setting the parameters.

Pressing **enter** opens a menu item.

The values are edited using ▲ and ▼.

Pressing **enter** confirms/stores the settings.

Return to measurement: Press **meas**.

Select menu group	Menu group	Code	Display	Select menu item
	Sensor selection	SNS:	CONF SENSOR	
		Menu item 1		↘ enter
		⋮		↘ enter
		Menu item ...		↘ enter
	Current output 1	OT1:	CONF OUT 1	↘ enter
▶ ↘	Current output 2	OT2:	CONF OUT 2	↘ enter
▶ ↘	Compensation	COR:	CONF CORRECTION	
▶ ↘	Alarm mode	ALA:	CONF ALARM	
▶ ↘	Setting the clock	CLK:	CONF CLOCK	↘ ◀
▶ ↘	Tag number	TAG:	CONF TAG	↘ ◀

Parameter Set A/B: Configurable Menu Groups



(Some parameters are identical in A and B. They are configured in parameter set A only.)

Menu group	Parameter set A	Parameter set B
SENSOR	Sensor selection	---
OUT1	Current output 1	Current output 1
OUT2	Current output 2	Current output 2
CORRECTION	Compensation	Compensation
ALARM	Alarm mode	Alarm mode
PARSET	Parameter set selection	---
CLOCK	Setting the clock	---
TAG	Tag number	---

Configuration

Parameter Set A/B

Manual selection

Display	Action	Remark
	To switch between parameter sets: Press meas (must have been selected in CONFIG)	Wrong settings change the measurement properties!
 The LCD display shows a pH reading of 7.23. Above the reading is a small 'A' in a square. To the right of the reading is an 'i' icon. Below the reading, 'PARSET B' is displayed with a left-pointing arrow to its left and a right-pointing arrow to its right. A 'meas' icon is in the bottom left corner.	PARSET blinks in the lower line. Select parameter set using ◀ and ▶ keys	
 The LCD display shows a pH reading of 7.23. Above the reading is a small 'A' in a square. To the right of the reading is an 'i' icon. Below the reading, 'PARSET A' is displayed with a left-pointing arrow to its left and a right-pointing arrow to its right. A 'meas' icon is in the bottom left corner.	Select PARSET A / PARSET B	
	Confirm with enter Cancel with meas	

Configuration		Choices	Default	
Sensor (SENSOR)				
SNS:		MEMOSENS INDUCON	MEMOSENS	
	TEMP UNIT	°C / °F	°C	
	TEMP MEAS	AUTO MAN EXT (only if enabled via TAN)	AUTO	
		MAN	-20...200 °C (-4...392 °F)	025.0 °C (077.0 °F)
	TEMP CAL	AUTO MAN EXT (only if enabled via TAN)	AUTO	
		MAN	-20...200 °C (-4...392 °F)	025.0 °C (077.0 °F)
	CAL MODE	AUTO MAN DAT	AUTO	
		AUTO BUFFER SET	-00-...-09-, -U1- Please note: Pressing info displays nominal buffer values and manufacturers	-00-
		U1 (specifiable buffer set)	EDIT BUFFER 1 (NO, YES) Enter values for buffer 1	NO
			EDIT BUFFER 2 (NO, YES) Enter values for buffer 2	NO

Configuration

Configuration		Choices	Default		
Sensor (SENSOR)					
SNS:	CAL TIMER		OFF FIX ADAPT	OFF	
	ON	CAL-CYCLE	0...9999 h	0168 h	
	DS (InduCon)	CIP COUNT		ON/OFF	OFF
		ON	CIP CYCLES	0...9999 CYC	0025 CYC
		SIP COUNT		ON/OFF	OFF
		ON	SIP CYCLES	0...9999 CYC	0025 CYC
Output 1 (OUT1)					
OT1:	CHANNEL		PH/ORP/TMP	PH	
	PH	BEGIN	-2.00...16 PH	00.00 PH	
		END	-2.00...16 PH	14.00 PH	
	ORP	BEGIN	-1999...1999 mV		
		END	-1999...1999 mV		
	TMP °C	BEGIN	-20...300 °C		
		END	-20...300 °C		
	TMP °F	BEGIN	-4...572 °F		
		END	-4...572 °F		
	FILTERTIME		0...120 SEC	0000 SEC	
	22mA-FAIL		ON/OFF	OFF	
	HOLD MODE		LAST/FIX	LAST	
	FIX	HOLD-FIX	4...22 mA	021.0 mA	

Configuration		Choices	Default	
Output 2 (OUT2)				
OT2:	CHANNEL	PH/ORP/TMP	TMP	
	... other steps like output 1			
Temperature compensation (CORRECTION)				
COR:	TC LIQUID		-19.99...19.99%/K	00.00%/K
	TEMP EXT*		ON/OFF	OFF
	ON	I-INPUT	0...20 mA/ 4...20 mA	4...20 mA
		°C	BEGIN 4 mA	-20...200 °C
		END 20 mA	-20...200 °C	100.0 °C
	°F	BEGIN 4 mA	-4...392 °F	032.0 °F
		END 20 mA	-4...392 °F	212.0 °F
Alarm (ALARM)				
ALA:	DELAYTIME	0...600 SEC	0010 SEC	
	SENSOCHECK	ON/OFF	OFF	
Parameter set (PARSET)				
PAR:	Select fixed parameter set (A) or switch between A/B via control input or manually in measuring mode	PARSET FIX / CNTR INPUT / MANUAL	PARSET FIX (parameter set A fixed)	
Real-time clock (CLOCK)				
CLK:	FORMAT		24 h / 12 h	
	24 h	TIME hh/mm	00...23:00...59	00:00
	12 h	TIME hh/mm	00...11 AM/ PM:00...59	00.00
	DAY/MONTH		01...31/01...12	31.12.
	YEAR		2000...2099	2006
Tag number (TAG)				
TAG:	(Input in text line)		XXXXXXXXXX	

*) is only displayed if enabled and SENSOR TEMP EXT has been selected.

Configuration (Original for Copy)

Two complete parameter sets are stored in the EEPROM.
As delivered, the two sets are identical but can be edited.

Please note:

Fill in your configuration data on the following pages or use them as original for copy.

Parameter	Parameter set A	Parameter set B
SNS: Sensor type		--- *)
SNS: RTD type		---
SNS: Temperature unit		---
SNS: Temp measurement		---
SNS: Manual meas. temp		---
SNS: Calibration temp		---
SNS: Manual cal temp		---
SNS: Calibration mode		---
SNS: Buffer set selection (-U1-, see Appendix)		---
SNS: Calibration timer		---
SNS: Calibration cycle		---
SNS: CIP counter		---
SNS: CIP cycles		---
SNS: SIP counter		---
SNS: SIP cycles		---
OT1: Process variable		
OT1: Current start		
OT1: Current end		

*) These parameters cannot be adjusted in parameter set B, the values are the same as in parameter set A.

(Original for Copy) Configuration

Parameter	Parameter set A	Parameter set B
OT1: Filter time		
OT1: 22 mA error current		
OT1: HOLD mode		
OT1: HOLD-FIX current		
OT2: Process variable		
OT2: Current start		
OT2: Current end		
OT2: Filter time		
OT2: 22 mA error current		
OT2: HOLD mode		
OT2: HOLD-FIX current		
COR: Temp coefficient		
COR: Ext. temp input		
COR: Current range		
COR: Current start		
COR: Current end		
ALA: Alarm on/off		
ALA: Delay		
ALA: Sensocheck on/off		
PAR: Parameter set selection		---
CLK: Time format		---
CLK: Time hh/mm		---
CLK: Day/month		---
CLK: Year		---
TAG: Tag number		---

*) These parameters cannot be adjusted in parameter set B, the values are the same as in parameter set A.

Configuration

Sensor

Select: sensor type, temperature unit,
temp detection during measurement



enter



enter

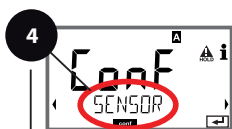

enter

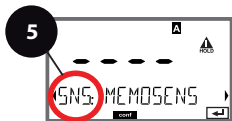

meas



- 1 Press any arrow key.
- 2 Select **CONF** using ◀ ▶ keys, press **enter**.
- 3 Select parameter set using ◀ ▶ keys, press **enter**.
- 4 Select **SENSOR** menu using ◀ ▶ keys, press **enter**.
- 5 All items of this menu group are indicated by the "SNS:" code. Press **enter** to select menu, edit with arrow keys (see next page). Confirm (and proceed) with **enter**.
- 6 End: Press **meas** key until the [meas] mode indicator is displayed.

5

Select sensor type	enter
Temperature unit	enter
Temp detection during measurement (Man. temperature)	enter
Temp detection during calibration (Man. temperature)	
Calibration mode (AUTO: Buffer set)	
Calibration timer	
Calibration cycle	
Cleaning cycles	
Cleaning cycle counter	
Sterilization cycles	
Sterilization cycle counter	

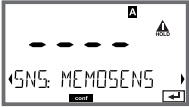
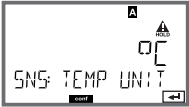
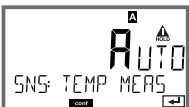
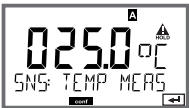
Menu item	Action	Choices
Select sensor type  <p>The screenshot shows a menu titled 'MEMOSENS' with a cursor on the left and a right arrow on the right. There are four dashes above the text. In the top right corner, there is a small 'A' icon and a triangle icon with 'MEMO' written below it. At the bottom, there is a 'Conf' button and a left arrow.</p>	Select sensor type using ▲ ▼ keys. Confirm with enter	MEMOSENS INDUCON
Temperature unit  <p>The screenshot shows a menu titled 'TEMP UNIT' with a cursor on the left and a right arrow on the right. In the top right corner, there is a small 'A' icon and a triangle icon with 'MEMO' written below it. At the bottom, there is a 'Conf' button and a left arrow.</p>	Select °C or °F using ▲ ▼ keys. Confirm with enter	°C / °F
Temp detection during measurement  <p>The screenshot shows a menu titled 'TEMP MEAS' with 'AUTO' displayed in large characters. In the top right corner, there is a small 'A' icon and a triangle icon with 'MEMO' written below it. At the bottom, there is a 'Conf' button and a left arrow.</p>	Select mode using ▲ ▼ : AUTO: Measured by sensor MAN: Direct input of temperature, no measurement (see next step) EXT: Temperature specified via current input (only if TAN E enabled) Confirm with enter	AUTO MAN EXT
(Manual temp)  <p>The screenshot shows a large digital display showing '025.0' followed by '°C'. Below the display is the text 'TEMP MEAS'. In the top right corner, there is a small 'A' icon and a triangle icon with 'MEMO' written below it. At the bottom, there is a 'Conf' button and a left arrow.</p>	Modify digit using ▲ ▼ , select next digit using ◀ ▶ keys. Confirm with enter	-20...200 °C (-4...+392 °F)

Configuration

Sensor

Select: temp detection during calibration, calibration mode



enter



enter

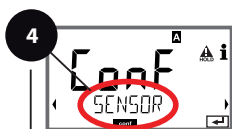

enter

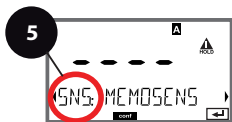



meas



- 1 Press any arrow key.
- 2 Select **CONF** using ◀ ▶ keys, press **enter**.
- 3 Select parameter set using ◀ ▶ keys, press **enter**.
- 4 Select **SENSOR** menu using ◀ ▶ keys, press **enter**.
- 5 All items of this menu group are indicated by the "SNS:" code.
Press **enter** to select menu, edit with arrow keys (see next page). Confirm (and proceed) with **enter**.
- 6 End: Press **meas** key until the [meas] mode indicator is displayed.

5

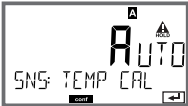
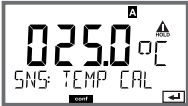
Select sensor type	enter
Temperature unit	
Temp detection during measurement	↻
(Man. temperature)	
Temp detection during calibration	↻
(Man. temperature)	
Calibration mode	↻
(AUTO: Buffer set)	
Calibration timer	↻
Calibration cycle	
Cleaning cycles	↻
Cleaning cycle counter	
Sterilization cycles	↻
Sterilization cycle counter	

Menu item	Action	Choices
Temp detection during calibration 	Select mode using ▲ ▼ : AUTO: Measured by sensor MAN: Direct input of temperature, no measurement (see next step) EXT: Temperature specified via current input (only if TAN E enabled) Confirm with enter	AUTO MAN EXT
(Manual temp) 	Modify digit using ▲ ▼ , select next digit using ◀ ▶ keys. Confirm with enter	-20...200 °C (-4...+392 °F)
Calibration Mode 	Select CALMODE using ▲ ▼ keys: AUTO: Calibration with Calimatic buffer set recognition MAN: Manual input of buffer solutions. DAT: Input of adjustment data of premeasured sensors Confirm with enter	AUTO MAN DAT
(AUTO: Buffer set) 	Select buffer set using ▲ ▼ keys (see buffer tables for nominal values). Confirm with enter	-00-...-09-, -U1- (see Appendix) Pressing the info key displays the manufacturer and nominal values in the lower line.

Configuration

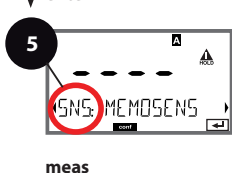
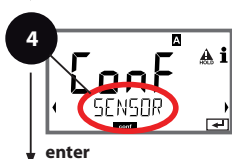

Sensor

Adjust: calibration timer, calibration cycle



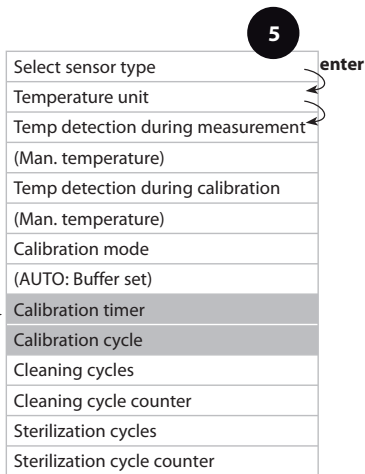



- 1 Press any arrow key.
- 2 Select **CONF** using ◀ ▶ keys, press **enter**.
- 3 Select parameter set using ◀ ▶ keys, press **enter**.
- 4 Select **SENSOR** menu using ◀ ▶ keys, press **enter**.
- 5 All items of this menu group are indicated by the "SNS:" code.
Press **enter** to select menu, edit with arrow keys (see next page). Confirm (and proceed) with **enter**.
- 6 End: Press **meas** key until the [meas] mode indicator is displayed.



Menu item	Action	Choices
Calibration timer 	Adjust CALTIMER using ▲ ▼ keys: OFF: No timer ADAPT: Maximum cal cycle (adjust in the next step) FIX: Fixed cal cycle (adjust in the next step) Confirm with enter	OFF/ADAPT/FIX With ADAPT, the calibra- tion cycle is automatically reduced depending on the sensor load (high temperatures and pH values) and for digital sensors also depending on the sensor wear
Calibration cycle 	Only with FIX/ADAPT: Modify digit using ▲ ▼ , select next digit using ◀ ▶ keys. Confirm with enter	0...9999 h

Note for the calibration timer:

When Sensocheck has been activated in the Configuration > Alarm menu, the expiration of the calibration interval is indicated by Sensoface:

Display	Status
 + 	Over 80% of the calibration interval has already past.
 + 	The calibration interval has been exceeded.

The calibration timer settings apply to both parameter sets A and B.

The time remaining until the next due calibration can be seen in the diagnostics menu (see Diagnostics chapter).

Configuration



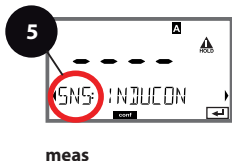
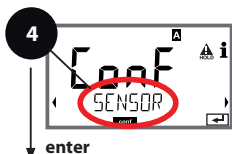

Sensor

Adjust: CIP cleaning cycles, SIP sterilization cycles

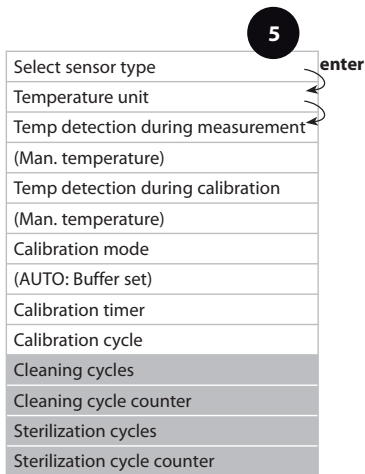

- 1 Press any arrow key.
- 2 Select **CONF** using ◀ ▶ keys, press **enter**.
- 3 Select parameter set using ◀ ▶ keys, press **enter**.
- 4 Select **SENSOR** menu using ◀ ▶ keys, press **enter**.
- 5 All items of this menu group are indicated by the "SNS:" code.
Press **enter** to select menu, edit with arrow keys (see next page). Confirm (and proceed) with **enter**.
- 6 End: Press **meas** key until the [meas] mode indicator is displayed.



Menu item	Action	Choices
CIP / SIP		
The following adjustments are possible for INDUCON digital sensors:		
Cleaning cycle counter 	Select ON or OFF using ▲ ▼ keys. Activates/deactivates logging in extended logbook and counters (if provided) Confirm with enter	ON/OFF
Cleaning cycles 	Only with CIP COUNT ON: Enter value using ▲ ▼ ◀ ▶ keys. Confirm with enter	0...9999 CYC (0025 CYC) Not with Memosens
Sterilization cycle counter 	Select ON or OFF using ▲ ▼ keys. Activates/deactivates logging in extended logbook and counters (if provided) Confirm with enter	ON/OFF
Sterilization cycles 	Only with SIP COUNT ON: Enter value using ▲ ▼ ◀ ▶ keys. Confirm with enter	0...9999 CYC (0025 CYC) Not with Memosens

The cleaning and sterilization cycles are counted to measure the load on the sensor.

Suitable for biochemical applications (process temp approx. 0...50 °C, CIP temperature > 55 °C, SIP temperature > 115 °C).

Configuration

Current Output 1

Process variable, current start, current end



enter



enter

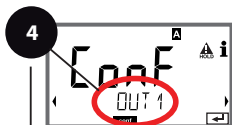

enter





meas



- 1 Press any arrow key.
- 2 Select **CONF** using ◀ ▶ keys, press **enter**.
- 3 Select parameter set using ◀ ▶ keys, press **enter**.
- 4 Select **OUT1** menu using ◀ ▶ keys, press **enter**.
- 5 All items of this menu group are indicated by the "OT1:" code.
Press **enter** to select menu, edit with arrow keys (see next page). Confirm (and proceed) with **enter**.
- 6 End: Press **meas** key until the [meas] mode indicator is displayed.

5

Process variable	enter
Current start	enter
Current end	enter
Time constant of output filter	
Output current during error message	
Output current during HOLD	
Output current for HOLD FIX	

Menu item	Action	Choices
Process variable 	Select using \blacktriangle \blacktriangledown keys: PH: pH value ORP: Redox potential TMP: Temperature Confirm with enter	PH/ORP/TMP
Current start 	Modify digit using \blacktriangle \blacktriangledown , select next digit using \blacktriangleleft \blacktriangleright keys. Confirm with enter	-2...16 pH (PH) -1999...1999 mV (ORP) -20...300 °C / -4...572 °F (TMP)
Current end 	Enter value using \blacktriangle \blacktriangledown \blacktriangleleft \blacktriangleright keys. Confirm with enter	-2...16 pH (PH) -1999...1999 mV (ORP) -20...300 °C / -4...572 °F (TMP)

Assignment of Measured Values: Current Start and Current End

Example 1: Range pH 0...14

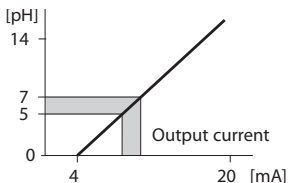

Example 2: Range pH 5...7

Advantage: Higher resolution in
[pH] range of interest

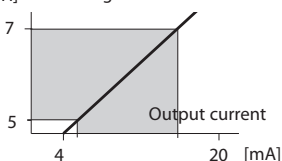

Configuration

Current Output 1

Adjust time constant of output filter

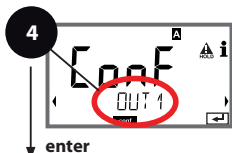

- 1 Press any arrow key.
- 2 Select **CONF** using ◀ ▶ keys, press **enter**.
- 3 Select parameter set using ◀ ▶ keys, press **enter**.
- 4 Select **OUT1** menu using ◀ ▶ keys, press **enter**.
- 5 All items of this menu group are indicated by the "OT1:" code.
Press **enter** to select menu, edit with arrow keys (see next page). Confirm (and proceed) with **enter**.
- 6 End: Press **meas** key until the [meas] mode indicator is displayed.

5

Current range	↩ enter
Process variable	↩
Current start	↩
Current end	
Time constant of output filter	
Output current during error message	
Output current during HOLD	
Output current for HOLD FIX	

Menu item	Action	Choices
Time constant of output filter	Enter value using \blacktriangle \blacktriangleright \blacktriangleleft \blacktriangleleft keys.	0...120 SEC (0000 SEC)
		Confirm with enter

Time Constant of Output Filter

To smoothen the current output, a low-pass filter with adjustable filter time constant can be switched on. When there is a jump at the input (100 %), the output level is at 63 % after the time constant has been reached. The time constant can be set from 0 to 120 sec. If the time constant is set to 0 sec, the current output directly follows the input.

Please note:

The filter only acts on the current output, not on the display!
During HOLD the filter is not applied. This prevents a jump at the output.

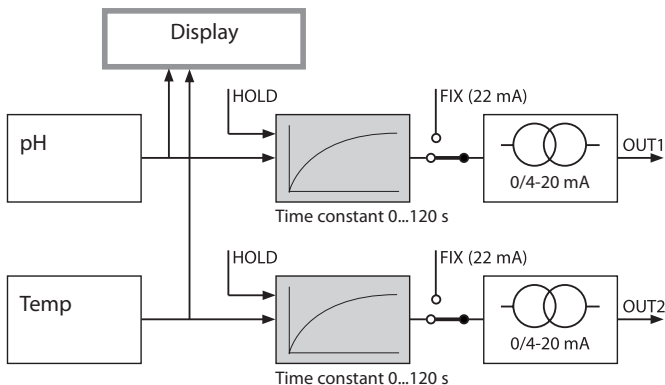

Configuration

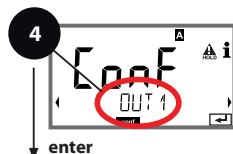

Current Output 1

Output current during Error and HOLD

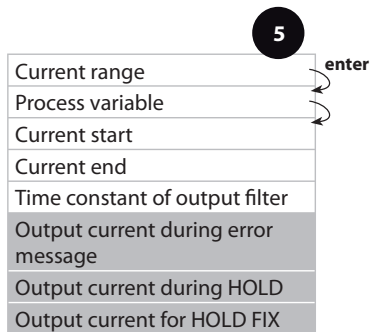

- 1 Press any arrow key.
- 2 Select **CONF** using ◀ ▶ keys, press **enter**.
- 3 Select parameter set using ◀ ▶ keys, press **enter**.
- 4 Select **OUT1** menu using ◀ ▶ keys, press **enter**.
- 5 All items of this menu group are indicated by the "OT1:" code.
Press **enter** to select menu, edit with arrow keys (see next page). Confirm (and proceed) with **enter**.
- 6 End: Press **meas** key until the [meas] mode indicator is displayed.



Menu item	Action	Choices
Output current during error message	Select ON or OFF using \uparrow \downarrow keys. Confirm with enter	ON/OFF
		
Output current during HOLD	LAST: During HOLD the last measured value is maintained at the output. FIX: During HOLD a value (to be entered) is maintained at the output. Select using \uparrow \downarrow Confirm with enter	LAST/FIX
		
Output current for HOLD FIX	Only with FIX selected: Enter current which is to flow at the output during HOLD Enter value using \uparrow \downarrow \leftarrow \rightarrow keys. Confirm with enter	00.00...22.00 mA (21.00 mA)
		

Output Signal During HOLD:

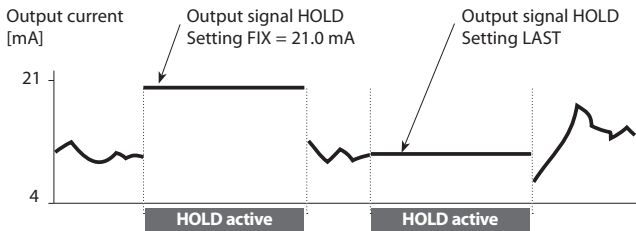

Configuration

Current Output 2

Output current range, current start, current end

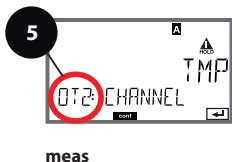
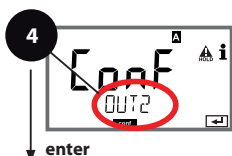

- 1 Press any arrow key.
- 2 Select **CONF** using ◀ ▶ keys, press **enter**.
- 3 Select parameter set using ◀ ▶ keys, press **enter**.
- 4 Select **OUT2** menu using ◀ ▶ keys, press **enter**.
- 5 All items of this menu group are indicated by the "OT2:" code.
Press **enter** to select menu, edit with arrow keys (see next page). Confirm (and proceed) with **enter**.
- 6 End: Press **meas** key until the [meas] mode indicator is displayed.

5

Process variable
Current start
Current end
Time constant of output filter
Output current during error message
Output current during HOLD
Output current for HOLD FIX

enter

Menu item	Action	Choices
Process variable 	Select using ▲ ▼ keys: PH: pH value ORP: Redox potential TMP: Temperature Confirm with enter	PH/ORP/TMP
<ul style="list-style-type: none"> • • • 		

All the following adjustments are made as for current output 1 (see there)!

Configuration

Temperature Compensation

TC process medium, current input for temp measurement



enter



enter



enter







meas

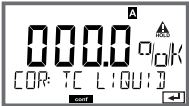
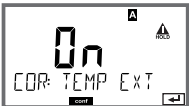

- 1 Press any arrow key.
- 2 Select **CONF** using ◀ ▶ keys, press **enter**.
- 3 Select parameter set using ◀ ▶ keys, press **enter**.
- 4 Select **CORRECTION** menu using ◀ ▶ keys, press **enter**.
- 5 All items of this menu group are indicated by the "COR:" code. Press **enter** to select menu, edit with arrow keys (see next page). Confirm (and proceed) with **enter**.
- 6 End: Press **meas** key until the [meas] mode indicator is displayed.

5

Temperature compensation, process medium	enter
Current input for ext. temperature measurement	↔
Current range	↔
Current start	
Current end	

Menu item	Action	Choices
Temp compensation, process medium 	For pH measurement only: Enter temperature compensation of the process medium. Enter value using \blacktriangle \blacktriangledown \blacktriangleleft \blacktriangleright keys. Confirm with enter	-19.99...+19.99 %/K
Current input for ext. temperature measurement 	Only if enabled via TAN and selected during configuration (SENSOR). Select ON or OFF using \blacktriangle \blacktriangledown keys. Confirm with enter	ON/OFF
Current range 	Select desired range using \blacktriangle \blacktriangledown keys. Confirm with enter	4-20 mA / 0-20 mA
Current start 	Modify digit using \blacktriangle \blacktriangledown , select next digit using \blacktriangleleft \blacktriangleright keys. Confirm with enter	Input range: -20...200 °C / -4...392 °F
Current end 	Enter value using \blacktriangle \blacktriangledown \blacktriangleleft \blacktriangleright keys. Confirm with enter	Input range: -20...200 °C / -4...392 °F

Configuration

Alarm

Alarm delay, Sensocheck



enter



enter



enter



meas





- 1 Press any arrow key.
- 2 Select **CONF** using ◀ ▶ keys, press **enter**.
- 3 Select parameter set using ◀ ▶ keys, press **enter**.
- 4 Select **ALARM** menu using ◀ ▶ keys, press **enter**.
- 5 All items of this menu group are indicated by the "ALA:" code. Press **enter** to select menu, edit with arrow keys (see next page). Confirm (and proceed) with **enter**.
- 6 End: Press **meas** key until the [meas] mode indicator is displayed.

Delay

Sensocheck

5

enter

Menu item	Action	Choices
<p>Alarm delay</p> 	<p>Only with Alarm ON selected: Enter value using ▲ ▼ ◀ ▶ keys. Confirm with enter</p>	<p>0...600 SEC (010 SEC)</p>
<p>Sensocheck</p> 	<p>Select Sensocheck (continuous monitoring of glass and reference electrode) Select ON or OFF using ▲ ▼ keys. Confirm with enter. (At the same time, Sensoface is activated. With OFF, Sensoface is also switched off.)</p>	<p>ON/OFF</p>

Error messages can be signaled by a 22 mA output current (see Error Messages and Configuration of Output 1/Output 2).

The alarm delay time delays the color change of the display backlighting to red and the 22 mA signal (if configured).

Configuration

Time and Date Tag Number

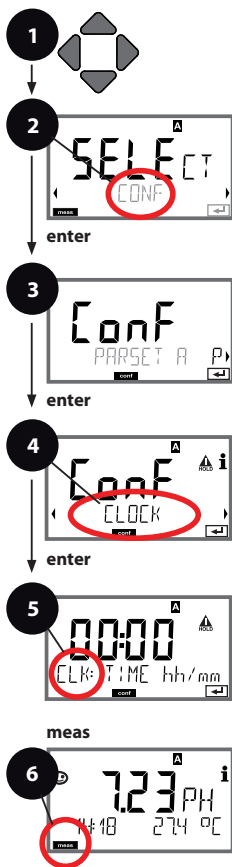

- 1 Press any arrow key.
- 2 Select **CONF** using ◀ ▶ keys, press **enter**.
- 3 Select parameter set A using ◀ ▶ keys, press **enter**.
- 4 Press **enter**.
- 5 Select **CLOCK** or **TAG** using ◀ ▶ keys, press **enter**.
- 6 All items of this menu group are indicated by the "CLK:" or "TAG" code. Press **enter** to select menu, edit with arrow keys (see next page). Confirm (and proceed) with **enter**.
- 7 End: Press **meas** key until the [meas] mode indicator is displayed.

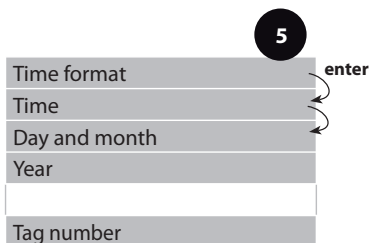

Time and Date

Control of the calibration and cleaning cycles is based on the time and date of the integrated real-time clock.

In measuring mode the time is shown in the lower display.

When using digital sensors, the calibration data is written in the sensor head.

In addition, the logbook entries (cf Diagnostics) are provided with a time stamp.

Please note:

- After prolonged power outage (> 5 days) the time display is replaced by dashes and cannot be used for processing.
Enter the correct time.
- There is no automatic switchover from winter to summer time!
Be sure to manually adjust the time!

Tag Number ("TAG")

You can enter a designation for the point of measurement (tag number) in the lower display line. Up to 32 digits are possible.

Pressing **meas** (repeatedly) in the measuring mode indicates the tag number.

Being part of the device configuration, the "TAG" can be read out via IrDA.

A standardized tag number helps, for example, to correctly re-install a device after repair.

5

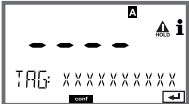
Menu item	Action	Choices
Tag number 	Select character using ▲ ▼ keys, select next digit using ◀ ▶ keys. Confirm with enter	A...Z, 0...9, - + < > ? / @ The first 10 characters are seen in the display with- out scrolling.

Digital Sensors

Operation

Stratos Pro can be operated with three different types of digital sensors (Memosens, InduCon).

The following display examples refer to a transmitter and a digital pH sensor (slight variations for other combinations).

The sensor type is selected during **configuration**.



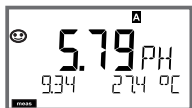

The device only switches to measuring mode when the connected sensor corresponds to the type configured (Sensoface is happy):

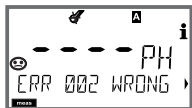

Otherwise, an error message is released. The **info** icon is displayed. You can display the error text in the bottom line using the ◀ ▶ keys. Sensoface is sad (see table of error messages and Sensoface in the Appendix):

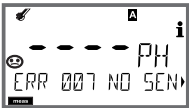

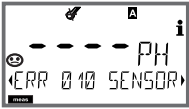

Connecting a Digital Sensor

Step	Action/Display	Remark
Connect sensor		Before a digital sensor is connected, the error message "No sensor" is displayed.
Wait until the sensor data are displayed.		The hourglass in the display blinks.
Check sensor data	 <p>View sensor information using ◀ ▶ keys, confirm with enter.</p>	The display color changes to green . Sensoface is happy.
Go to measuring mode	Press meas , info , or enter	After 60 sec the device automatically returns to measuring mode (timeout).
Possible error messages		
Sensor devaluated Replace sensor		When this error message appears, the sensor cannot be used any more. Sensoface is sad.
Sensor defective Replace sensor		When this error message appears, the sensor cannot be used. Sensoface is sad.

Sensor Replacement

A digital sensor should only be replaced during HOLD mode to prevent unintended reactions of the outputs or contacts. When you first want to calibrate the new sensor, it can also be replaced in calibration mode.

Step	Action/Display	Remark
Select HOLD mode	Press any key to call the selection menu, select HOLD using the ◀ ▶ keys, press enter to confirm.	Now the device is in HOLD mode. The HOLD mode can also be activated externally via the HOLD input. During HOLD the output current is frozen at its last value or set to a fixed value.
Disconnect and remove old sensor		
Install and connect new sensor.		Temporary messages which are activated during the replacement are indicated but not output to the alarm contact and not entered in the log-book.
Wait until the sensor data are displayed.		

Step	Action/Display	Remark
Check sensor data	 <p>View sensor information using ◀ ▶ keys, confirm with enter.</p>	You can view the sensor manufacturer and type, serial number, and last calibration date.
Check measured values		
Exit HOLD	<p>Hit meas key: Return to selection menu.</p> <p>Hold meas key depressed: Device switches to measuring mode</p>	The sensor replacement is entered in the extended logbook.

Calibration

Please note:

- All calibration procedures must be performed by trained personnel. Incorrectly set parameters may go unnoticed, but change the measuring properties.
- The response time of the sensor and temperature probe is considerably reduced when the sensor is first moved about in the buffer solution and then held still.
- The device can only operate properly when the buffer solutions used correspond to the configured set. Other buffer solutions, even those with the same nominal values, may demonstrate a different temperature response. This leads to measurement errors.

When using ISFET sensors or sensors with a zero point other than pH 7, the nominal zero point must be adjusted each time a new sensor is connected. This is important if you want to obtain reliable Sensoface messages. The Sensoface messages issued during all further calibrations are based on this basic calibration.

Selecting a Calibration Mode

Calibration is used to adapt the device to the individual sensor characteristics, namely asymmetry potential and slope.

Access to calibration can be protected with a passcode (SERVICE menu).

First, you open the calibration menu and select the calibration mode:

CAL_PH	Depending on configuration setting: AUTO Automatic buffer recognition (Calimatic) MAN Manual buffer input DAT Input of premeasured electrode data
CAL_ORP	ORP calibration
P_CAL	Product calibration (calibration with sampling)
ISFET-ZERO	Zero adjustment. Required for ISFET sensors, subsequently you can conduct either a one or a two-point calibration.
CAL_RTD	Temperature probe adjustment

To preset CAL_PH (CONF menu / configuration):

- 1) Hold **meas** key depressed (> 2 s) (measuring mode)
- 2) Press any arrow key: the selection menu appears
- 3) Select CONF mode using left / right arrow key
- 4) Select "SENSOR" – "CALMODE": AUTO, MAN, or DAT.

Press **enter** to confirm

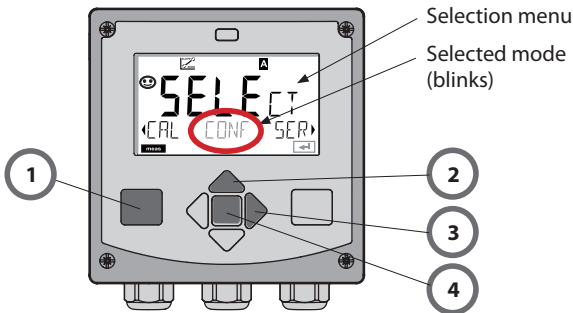





Zero Adjustment (ISFET)

This adjustment allows the use of ISFET sensors with differing nominal zero (pH only). The function is available when Sensor selection = MEMOSENS has been set during configuration. Zero adjustment is disabled for any other sensors.



The adjustment is made using a zero buffer (pH 7.00).

Permitted range for buffer value: pH 6.5 ... 7.5.

Temperature-corrected input. Maximum zero offset: ± 200 mV.

Display	Action	Remark
 The screen displays 'CAL' in large digits, with 'ISFET-ZERO' below it. There are left and right arrow keys and a 'CAL' button at the bottom.	Select Calibration. Press enter to proceed.	
 The screen displays 'CAL' in large digits, with 'ISFET-ZERO' below it. An hourglass icon is visible in the top right corner. There are left and right arrow keys and a 'CAL' button at the bottom.	Ready for calibration. Hourglass blinks.	Display (3 sec) Now the device is in HOLD mode.
 The screen displays '7.00' in large digits, with 'BUF' to the right. Below it, '127mV' and '27.3°C' are shown. There are left and right arrow keys and a 'CAL' button at the bottom.	Immerse sensor in a pH 7.00 buffer. Enter the temperature-corrected pH value in the range 6.50 to 7.50 using the arrow keys (see buffer table). Confirm with enter .	If the zero offset of the sensor is too large ($> \pm 200$ mV), a CAL ERR error message is generated. In that case the electrode cannot be calibrated.
 The screen displays '7.00' in large digits, with 'BUF' to the right. Below it, '128mV' and '27.3°C' are shown. An hourglass icon is visible in the top right corner. There are left and right arrow keys and a 'CAL' button at the bottom.	Stability check. The measured value [mV] is displayed. The "hourglass" icon is blinking.	Please note: Stability check can be stopped (by pressing enter). However, this reduces calibration accuracy.

Zero Adjustment (ISFET)





Display	Action	Remark
 The display shows a large '129' with 'mV' to its right. Below it, 'ISFET-ZERO' is displayed. There are small icons in the top corners and a 'CAL' label at the bottom left.	At the end of the adjustment procedure the zero offset [mV] of the sensor is displayed (based on 25 °C). Sensoface is active. Press enter to proceed.	This is not the final calibration value of the sensor! Asymmetry potential and slope must be determined with a complete 2-point calibration.
 The display shows '7.23 PH'. Below it, 'MEAS REPE' is displayed with a right-pointing arrow. There are small icons in the top corners and a 'CAL' label at the bottom left.	Use the arrow keys to select: <ul style="list-style-type: none">• Repeat (repeat calibration) or• Measuring. Confirm with enter .	
 The display shows '7.23 PH'. Below it, 'GOOD BYE' is displayed with dashes on either side. There are small icons in the top corners and a 'CAL' label at the bottom left.	Place sensor in process. End zero calibration with enter .	After end of calibration, the outputs remain in HOLD mode for a short time.

Note for Zero Adjustment







After having adjusted the zero offset, be sure to calibrate the sensor following one of the procedures as described on the next pages.

Automatic Calibration (Calimatic)

The AUTO calibration mode and the type of temperature detection are selected during **configuration**. Make sure that the buffer solutions used correspond to the configured buffer set. Other buffer solutions, even those with the same nominal values, may demonstrate a different temperature response. This leads to measurement errors.

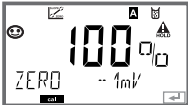



Display	Action	Remark
	Select Calibration. Press enter to proceed.	
	Ready for calibration. Hourglass blinks. Select calibration method: CAL_PH Press enter to proceed.	Display (3 sec) Now the device is in HOLD mode.
	Remove the sensor and temperature probe, clean them, and immerse them in the first buffer solution (in any order). Start with enter	When manual input of temperature has been configured, the temp value in the display blinks and can be edited using the arrow keys.
	Buffer recognition. While the "hourglass" icon is blinking, the sensor and temperature probe remain in the first buffer solution.	The response time of the sensor and temperature probe is considerably reduced when the sensor is first moved about in the buffer solution and then held still.
	Buffer recognition terminated, the nominal buffer value is displayed.	

Automatic Calibration (Calimatic)





Display	Action	Remark
	<p>At the end of the stability check, the value will be saved and the asymmetry potential will be displayed.</p> <p>Calibration with the first buffer is terminated.</p> <p>Remove the sensor and temp probe from the first buffer solution and rinse them thoroughly.</p> <p>Use the arrow keys to select:</p> <ul style="list-style-type: none"> • END (1-point cal) • CAL2 (2-point cal) • REPEAT <p>Press enter to proceed.</p>	<p>Please note:</p> <p>Stability check can be stopped after 10 sec (by pressing enter). However, this reduces calibration accuracy. Display for 1-point cal:</p>
	<p>Press enter to proceed.</p>	 <p>Sensoface is active. End with enter</p>
	<p>2-point calibration: Immerse sensor and temperature probe in the second buffer solution. Start with enter</p>	<p>The calibration process runs as for the first buffer.</p>
	<p>Retract sensor and temp probe out of second buffer, rinse off, re-install.</p> <p>Press enter to proceed.</p>	<p>The slope and asymmetry potential of the sensor (based on 25 °C) are displayed.</p>
	<p>Use the arrow keys to select:</p> <ul style="list-style-type: none"> • MEAS (end) • REPEAT <p>Press enter to proceed.</p> <p>End: HOLD is deactivated with delay.</p>	<p>When 2-point cal is ended:</p> 

Manual Calibration with Buffer Entry

The MAN calibration mode and the type of temperature detection are selected during **configuration**. For calibration with manual buffer specification, you must enter the pH value of the buffer solution used in the device for the proper temperature. Any desired buffer solution can be used for calibration.

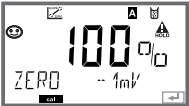
Display	Action	Remark
 The display shows 'CAL' in large characters, with 'CAL_PH' below it. There are navigation arrows on the left and right sides, and a battery icon and a warning icon at the top right.	Select Calibration. Press enter to proceed.	
 The display shows 'CAL' in large characters, with 'BUFFER MANUAL' below it. There is a smiley face icon on the left, a battery icon and a warning icon at the top right, and a small hourglass icon at the bottom left.	Ready for calibration. Hourglass blinks.	Display (3 sec) Now the device is in HOLD mode.
 The display shows 'CAL M 1' in large characters. Below it, '1431' and '27.40C' are displayed. There are navigation arrows on the left and right sides, and a battery icon and a warning icon at the top right.	Remove the sensor and temperature probe, clean them, and immerse them in the first buffer solution. Press enter to start.	When manual input of temperature has been configured, the temp value in the display blinks and can be edited using the arrow keys.
 The display shows '07.00' in large characters, with 'BUF' to the right. Below it, '1431' and '27.40C' are displayed. There are navigation arrows on the left and right sides, and a battery icon and a warning icon at the top right.	Enter the pH value of your buffer solution for the proper temperature. While the "hourglass" icon is blinking, the sensor and temperature probe remain in the buffer solution.	The response time of the sensor and temperature probe is considerably reduced when the sensor is first moved about in the buffer solution and then held still.
 The display shows '7.00' in large characters, with 'mV' and '27.30C' below it. There is a small hourglass icon at the bottom left, and a battery icon and a warning icon at the top right.		







Manual Calibration with Buffer Entry

Display	Action	Remark
	<p>At the end of the stability check, the value will be saved and the asymmetry potential will be displayed.</p> <p>Calibration with the first buffer is terminated.</p> <p>Remove the sensor and temp probe from the first buffer solution and rinse them thoroughly.</p> <p>Use the arrow keys to select:</p> <ul style="list-style-type: none"> • END (1-point cal) • CAL2 (2-point cal) • REPEAT <p>Press enter to proceed.</p>	<p>Please note: Stability check can be stopped after 10 sec (by pressing enter). However, this reduces calibration accuracy. Display for 1-point cal:</p>  <p>Sensoface is active. End with enter</p>
	<p>2-point calibration: Immerse sensor and temperature probe in the second buffer solution.</p> <p>Enter pH value.</p> <p>Press enter to start.</p>	<p>The calibration process runs as for the first buffer.</p>
	<p>Rinse sensor and temperature probe and reinstall them.</p> <p>Press enter to proceed.</p>	<p>Display of slope and new asymmetry potential (based on 25 °C).</p>
	<p>Use the arrow keys to select:</p> <ul style="list-style-type: none"> • MEAS (end) • REPEAT <p>Press enter to proceed.</p> <p>End: HOLD is deactivated with delay.</p>	<p>When 2-point cal is ended:</p> 

Data Entry of Premeasured Sensors

The DAT calibration mode must have been preset during configuration.

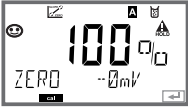
You can directly enter the values for slope and asymmetry potential of a sensor. The values must be known, e.g. determined beforehand in the laboratory.

Display	Action	Remark
	Select Calibration. Press enter to proceed.	
	“Data Input” Ready for calibration. Hourglass blinks.	Display (3 sec) Now the device is in HOLD mode.
	Enter asymmetry potential [mV]. Press enter to proceed.	
	Enter slope [%].	
	The device displays the new slope and asymmetry potential (at 25 °C). Sensoface is active.	
	Use the arrow keys to select: • MEAS (end) • REPEAT Press enter to proceed.	End: HOLD is deactivated with delay.

Converting slope [%] to slope [mV/pH] at 25 °C

%	mV/pH
78	46,2
80	47,4
82	48,5
84	49,7
86	50,9
88	52,1
90	53,3
92	54,5
94	55,6
96	56,8
98	58,0
100	59,2
102	60,4

Converting asymmetry potential to sensor zero point

$$\text{ZERO} = 7 - \frac{V_{AS} [\text{mV}]}{S [\text{mV} / \text{pH}]}$$

ZERO = Sensor zero

V_{AS} = Asymmetry potential

S = Slope

Product Calibration (pH)

Calibration by sampling (one-point calibration).

During product calibration the sensor remains in the process.



The measurement process is only interrupted briefly.

Procedure:



- 1) The sample is measured in the lab or directly on the site using a portable meter. To ensure an exact calibration, the sample temperature should correspond to the measured process temperature. During sampling the device saves the currently measured value and then returns to measuring mode. The "calibration" mode indicator blinks.
- 2) In the second step you enter the measured sample value in the device. From the difference between the stored measured value and entered sample value, the device calculates the new asymmetry potential.

If the sample is invalid, you can take over the value stored during sampling. In that case the old calibration values are stored.

Afterwards, you can start a new product calibration.

Display	Action	Remark
	Select product calibration: P_CAL. Press enter to proceed.	
	Ready for calibration. Hourglass blinks.	Display (3 sec) Now the device is in HOLD mode.
	Take sample and save value. Press enter to proceed.	Now the sample can be measured.

Product Calibration (pH)

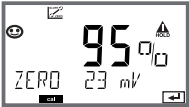
Display	Action	Remark
	The device returns to measuring mode.	From the blinking CAL mode indicator you see that product calibration has not been terminated.
	Product calibration step 2	Display (3 sec) Now the device is in HOLD mode.
	The stored value is displayed (blinking) and can be overwritten with the measured sample value. Press enter to proceed.	
	Display of new asymmetry potential (based on 25°C). Sensoface is active. To end calibration: Select MEAS, then enter	To repeat calibration: Select REPEAT, then enter
End of calibration	After end of calibration, the outputs remain in HOLD mode for a short time.	

ORP (Redox) Calibration

The potential of a redox sensor is calibrated using a redox (ORP) buffer solution. In the course of that, the difference between the measured potential and the potential of the calibration solution is determined according to the following equation. During measurement this difference is added to the measured potential.

$$mV_{\text{ORP}} = mV_{\text{meas}} + \Delta mV$$

mV_{ORP} = displayed ORP

mV_{meas} = direct sensor potential





ΔmV = delta value, determined during calibration

The sensor potential can also be related to another reference system – e.g. the standard hydrogen electrode. In that case the temperature-corrected potential (see table) of the reference electrode used must be entered during calibration. During measurement, this value is then added to the ORP measured.





Please make sure that measurement and calibration temperature are the same since the temperature behavior of the reference electrode is not automatically taken into account.





Temperature Dependence of Commonly Used Reference Systems Measured Against SHE

Temperature [°C]	Ag/AgCl/KCl 1 mol/l [ΔmV]	Ag/AgCl/KCl 3 mol/l [ΔmV]	Thalamid [ΔmV]	Mercury sulfate [ΔmV]
0	249	224	-559	672
10	244	217	-564	664
20	240	211	-569	655
25	236	207	-571	651
30	233	203	-574	647
40	227	196	-580	639
50	221	188	-585	631
60	214	180	-592	623
70	207	172	-598	613
80	200	163	-605	603

Display	Action	Remark
	Select ORP calibration, proceed with enter	
	Remove the sensor and temperature probe, clean them, and immerse them in the redox buffer.	Display (3 sec) Now the device is in HOLD mode.
	Enter setpoint value for redox buffer. Press enter to proceed.	
	The ORP delta value is displayed (based on 25°C). Sensoface is active. Press enter to proceed.	
	To repeat calibration: Select REPEAT. To end calibration: Select MEAS, then press enter	After end of calibration, the outputs remain in HOLD mode for a short time.

Temp Probe Adjustment

Display	Action	Remark
 The display shows 'CAL' in large characters at the top. Below it, 'CAL RTD' is visible. There are navigation arrows on the left and right sides of the screen.	Select temp adjustment. Press enter to proceed.	Wrong settings change the measurement properties!
 The display shows 'CAL' at the top, followed by 'TEMP ADJUST' in smaller characters. A warning triangle icon is in the top right corner.	Measure the temperature of the process medium using an external thermometer.	Display (3 sec) Now the device is in HOLD mode.
 The display shows '25.0' in large characters with a degree Celsius symbol. Below it, 'ADJUST' and '235.0' are visible. A warning triangle icon is in the top right corner.	Enter the measured temperature value. Maximum difference: 10 K. Press enter to proceed.	Display of actual temperature (uncompensated) in the lower display.
 The display shows '25.0' in large characters with a degree Celsius symbol. Below it, 'MEAS' is visible. A smiley face icon is in the top left corner, and a warning triangle icon is in the top right corner.	The corrected temperature value is displayed. Sensoface is active. To end calibration: Select MEAS, then enter To repeat calibration: Select REPEAT, then enter	
 The display shows '7.23' in large characters with 'PH' below it. Below that, 'GOOD BYE' is visible. A smiley face icon is in the top left corner, and a warning triangle icon is in the top right corner.	After calibration is ended, the device will switch to measuring mode.	After end of calibration, the outputs remain in HOLD mode for a short time.

Display	Remark
	<p>From the configuration or calibration menus, you can switch the device to measuring mode by pressing the meas key.</p> <p>In the measuring mode the main display shows the configured process variable (pH, ORP [mV], or temperature), the secondary display shows the time and the second configured process variable (pH, ORP [mV], or temperature). The [meas] mode indicator lights and the active parameter set (A/B) is indicated.</p>
	
<p>By pressing the enter key you can briefly display the output currents.</p> <p>By pressing the meas key you can step through the following displays. When no key has been pressed for 60 sec, the device returns to the standard display.</p>	
	<p>1) Selecting the parameter set (if set to "manual" in the configuration). Select the desired parameter set using the ◀ ▶ arrow keys (PARSET A or PARSET B blinks in the lower display line). Confirm with enter.</p> <p>Further displays (each with meas).</p> <p>2) Display of tag number ("TAG")</p> <p>3) Display of time and date</p>
	
	

Diagnostics

In the Diagnostics mode you can access the following menus without interrupting the measurement:







CALDATA	Viewing the calibration data
SENSOR	Viewing the sensor data
SELFTEST	Starting a device self-test
LOGBOOK	Viewing the logbook entries
MONITOR	Displaying currently measured values
VERSION	Displaying device type, software version, serial number





Access to diagnostics can be protected with a passcode (SERVICE menu).



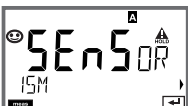

Please note:

HOLD is not active during Diagnostics mode!







Action	Key	Remark
Activate Diagnostics		Press any arrow key to call the selection menu. (Display color changes to turquoise.) Select DIAG using ◀ ▶ keys, confirm with enter
Select diagnostics option		Use ◀ ▶ keys to select from: CALDATA SENSOR SELFTEST LOGBOOK MONITOR VERSION See next pages for further proceeding.
End	meas	End with meas .

Display	Menu item
	<p>Display of calibration data</p> <p>Select CALDATA using ◀ ▶, confirm with enter. Use the ◀ ▶ keys to select the desired parameter from the bottom line of the display (LAST_CAL ISFET-ZERO ZERO SLOPE NEXT_CAL). The selected parameter is shown in the main display.</p>
	<p>Press meas to return to measurement.</p>
	
	
	
	
	<p>Display data using ◀ ▶ keys, return with enter or meas.</p>

Display	Menu item
	Device self-test (To abort, you can press meas)
	1) Display test: Display of all segments with changing background colors white/green/red. Proceed with enter
	2) RAM test: Hourglass blinks, then display of --PASS-- or --FAIL-- Proceed with enter
	3) EEPROM test: Hourglass blinks, then display of --PASS-- or --FAIL-- Proceed with enter
	4) FLASH test: Hourglass blinks, then display of --PASS-- or --FAIL-- Proceed with enter
	5) Module test: Hourglass blinks, then display of --PASS-- or --FAIL-- Press enter or meas to return to measuring mode.

Display	Menu item
	<p>Display of logbook entries Select LOGBOOK using ◀ ▶, confirm with enter.</p> <p>With the ▲ ▼ keys, you can scroll backwards and forwards through the logbook (entries -00...-99-), -00- being the last entry.</p>
	<p>If the display is set to date/time, you can search for a particular date using the ▲ ▼ keys. Press ◀ ▶ to view the corresponding message text.</p>
	<p>If the display is set to the message text, you can search for a particular message using the ▲ ▼ keys. Press ◀ ▶ to display the date and time.</p> <p>Press meas to return to measurement.</p>
	<p>Extended logbook / Audit Trail (via TAN) With the ▲ ▼ keys, you can scroll backwards and forwards through the extended logbook (entries -000...-199-), -000- being the last entry.</p> <p>Display: CFR Audit Trail also records function activations (CAL CONFIG SERVICE), some Sensoface messages (cal timer, wear), and opening of the enclosure.</p>

Diagnostics



Display	Menu item
	Display of currently measured values (sensor monitor) Select MONITOR using ◀ ▶, confirm with enter . Use the ◀ ▶ keys to select the desired parameter from the bottom line of the display: mV_PH mV_ORP RTD R_GLASS R_REF I-INPUT (for digital sensors also: OPERATION TIME SENSOR WEAR LIFETIME CIP SIP AUTOCLAVE). The selected parameter is shown in the main display. Press meas to return to measurement.
<p>Display example:</p> 	Display mV_pH (for validation, sensor can be immersed in a calibration solution, for example, or the device is checked by using a simulator)
	Display of remaining dynamic lifetime (only for digital sensors, however not for MEMOSENS)
	Display of sensor operating time (for digital sensors only)
	Display of sensor wear (only for digital sensors of the InduCon type)
	Version Display of device type, software/hardware version, and serial number for all device components. Use the ▲ ▼ keys to switch between software and hardware version. Press enter to proceed to next device component.

The Service mode allows



- displaying the currently measured values with the sensor monitor
- performing a device self-test
- testing the two current outputs
- activating and communicating via the IrDA interface
- assigning and editing passcodes
- resetting the device to factory settings
- enabling options via TAN.



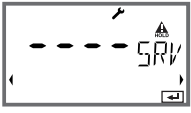

Please note:

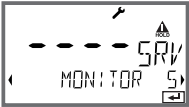
HOLD is active during Service mode!

















Action	Key/Display	Remark
Activate Service		Press any arrow key to call the selection menu. (Display color changes to green) Select SERVICE using ◀ ▶ keys, confirm with enter
Passcode		Enter passcode "5555" for service mode using the ▲ ▼ ◀ ▶ keys. Confirm with enter .
Display		In service mode the following icons are displayed: <ul style="list-style-type: none"> • [diag] mode indicator • HOLD triangle • Service (wrench)
End	meas	End with meas .

Service

Menu item	Remark
 <p>Display example:</p> 	<p>Display of currently measured values (sensor monitor) with HOLD mode activated: Select MONITOR using ◀ ▶, confirm with enter. Select variable in the bottom text line using ◀ ▶.</p> <p>The selected parameter is shown in the main display. As the device is in HOLD mode, you can perform validations using simulators without influencing the signal outputs.</p> <p>Press meas to return to the service menu. Return to measurement: Press meas once more.</p>
	<p>Specify current at outputs 1 and 2: Select OUT1 or OUT2 using the ◀ ▶ keys, confirm with enter. Enter a valid current value for the respective output using ▲ ▼ ◀ ▶ keys. Confirm with enter. For checking purposes, the actual output current is shown in the bottom right corner of the display. End with enter or meas.</p>

Menu item	Remark
	<p>IrDA communication: Select IRDA using ◀ ▶, confirm with enter.</p>
	<p>When IrDA communication is active, the device remains in the HOLD mode for reasons of safety. Further operation is performed via IrDA.</p> <p>End communication with meas.</p> <p>Exception: Firmware update (must not be interrupted!)</p>
	<p>Assigning passcodes: In the "SERVICE - CODES" menu you can assign passcodes to DIAG, HOLD, CAL, CONF, and SERVICE modes (Service preset to 5555).</p> <p>When you have lost the Service passcode, you have to request an "Ambulance TAN" from the manufacturer specifying the serial number of your device. To enter the "Ambulance TAN", call the Service function and enter passcode 7321. After correct input of the ambulance TAN the device signals "PASS" for 4 sec and resets the Service passcode to 5555.</p>
	<p>Reset to factory settings: In the "SERVICE - DEFAULT" menu you can reset the device to factory settings. Not affected: calibration data</p>
	<p>Release of options: Options come with a "transaction number" (TAN). This TAN must be entered and confirmed with enter to release the option.</p>

Operating States

Operating status	OUT 1	OUT 2	Time out
Measuring			-
DIAG			60 s
CAL			No
CONF			20 min
SERVICE			20 min
SERVICE OUT 1			20 min
SERVICE OUT 2			20 min
HOLD			No

Explanation:



as configured (Last/Fix or Last/Off)



active



manual

Product Line and Accessories

Order Code Stratos Pro A 2...

								TAN		
Example	A	2	1	1	X	-	PH	-	1	
2-wire / 4-20 mA	A	2								B,C,E
Communication										
Without (HART retrofittable via TAN)			0							A
HART			1							
PROFIBUS PA			2							
Foundation Fieldbus FF			3							
Version number										
Version				1						
Approvals										
General Safety					N					
ATEX / IECEX Zone 2					B					
ATEX / IECEX / FM / CSA Zone 1 / CI 1 Div 1					X					
Other approvals					Z					
Measuring channel										
Memosens pH / Redox	digital						MSPH			
Memosens Cond	digital						MSCOND			
Memosens Oxy	digital						MSOXY			
Dual COND (2x2-electrode sensors, analog)				N			CC			
pH / ORP value (ISM digital per TAN)	Measuring module						PH			F
Cond, 2-/4-electrode	Measuring module						COND			
Conductivity, electrodeless	Measuring module						CONDI			
Oxygen (ISM digital and traces per TAN)	Measuring module						OXY			D, F
Carbon dioxide (ISM digital per TAN)	Measuring module						CO2			
Options										
Without 2nd current output									0	
With 2nd current output									1	
TAN options										
HART							SW-A001			(A)
Logbook							SW-A002			(B)
Extended logbook (Audit Trail)							SW-A003			(C)
Trace oxygen measurement							SW-A004			(D)
Current input + 2 digital inputs							SW-A005			(E)
ISM digital							SW-A006			(F)
Mounting accessories										
Pipe-mount kit							ZU 0274			
Protective hood							ZU 0737			
Panel-mount kit							ZU 0738			

A201/A211X: Supply Units and Connection

Recommended Power Supply Units:	Order No.:
Repeater power supply, IS, 24 V AC/DC, output 0/4...20 mA	WG 20 A2
Repeater power supply, IS, 90...253 V AC, output 4...20 mA	WG 21 A7
Repeater power supply, IS, 90...253 V AC, HART, output 4...20 mA	WG 21 A7 Opt. 470
Repeater power supply, IS, 24 V AC/DC, output 4...20 mA	WG 21 A7 Opt. 336
Repeater power supply, IS, 24 V AC/DC, HART, output 4...20 mA	WG 21 A7 Opt. 336, 470
Repeater power supply, non-IS, 24 V DC, output 4...20 mA	IsoAmp PWR B 10116
Repeater power supply, non-IS, 24 V DC, HART, output 0/4...20 mA / 0...10 V	IsoAmp PWR A 20100

Connection to Supply Units

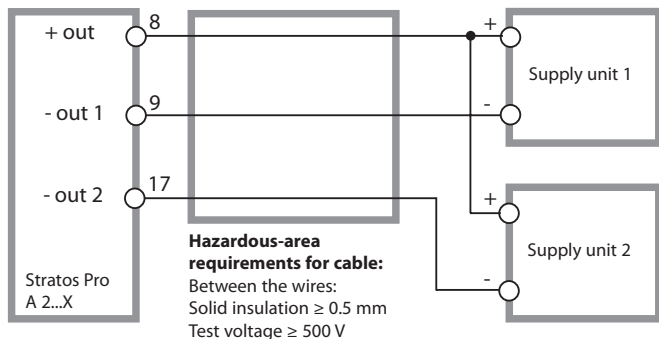

Specifications

pH input	Input for digital sensors (RS485)	
Display range	pH value	-2.00 ... 16.00
pH sensor standardization *	pH calibration	
Operating modes	BUF	Calibration with Calimatic automatic buffer recognition
	MAN	Manual calibration with input of individual buffer values
	DAT	Data entry of pre-measured electrodes
	Product calibration	
Calimatic buffer sets *	-00- Knick	2.00/4.01/7.00/9.21
	-01- Mettler-Toledo	2.00/4.01/7.00/9.21
	-02- Merck/Riedel	2.00/4.00/7.00/9.00/12.00
	-03- Ciba (94)	2.06/4.00/7.00/10.00
	-04- NIST technical	1.68/4.00/7.00/10.01/12.46
	-05- NIST standard	1.679/4.006/6.865/9.180
	-06- HACH	4.00/7.00/10.01
	-07- WTW techn. buffers	2.00/4.01/7.00/10.00
	-08- Hamilton	4.01/7.00/10.01
	-09- Reagecon	2.00/4.00/7.00/9.00/12.00
	-U1-	Specifiable buffer set
Zero adjustment	± 200 mV (for ISFET)	
Max. calibration range	Asymmetry potential	±60 mV
	Slope	80 ... 103 % (47.5 ... 61 mV/pH)
	(possibly restricting notes from Sensoface)	
ORP sensor standardization *	ORP calibration (zero adjustment)	
Max. calibration range	-700 ... +700 ΔmV	
Adaptive cal timer *	Interval 0000 ... 9999 h	
(German patent DE 101 41 408)		
Sensocheck	Automatic monitoring of glass and reference electrode, can be disabled	
Delay	Approx. 30 s	

Specifications

Sensoface	Provides information on the sensor condition, evaluation of zero/slope, response time, calibration interval, wear, Sensocheck, can be switched off
I input	Current input 0/4 ... 20 mA / 50 Ω for external temperature signal
Start/end of scale	Configurable within the measurement range for °C (°F)
Characteristic	Linear
Measurement error ^{1,3)}	< 1% current value + 0.1 mA
HOLD input	Galvanically separated (OPTO coupler)
Function	Switches device to HOLD mode
Switching voltage	0 ... 2 V (AC/DC) Inactive 10 ... 30 V (AC/DC) HOLD active
CONTROL input	Galvanically separated (OPTO coupler)
Function	Selecting parameter set A/B
Switching voltage	0 ... 2 V (AC/DC) Parameter set A 10 ... 30 V (AC/DC) Parameter set B
Output 1	Current loop 4 ... 20 mA, floating, protected against inverse polarity HART communication
Supply voltage	14 ... 30 V
Process variable*	pH, ORP, or temperature
Characteristic	Linear
Overrange *	22 mA in the case of error messages
Output filter *	PT ₁ filter, time constant 0 ... 120 s
Measurement error ¹⁾	< 0.25 % current value + 0.025 mA
Start/end of scale *	Configurable within the measurement ranges for pH, mV, °C, °F
Min. span	pH 2.00 / 200 mV / 20 K / 36 °F

Output 2	Current loop 4 ... 20 mA, floating, protected against inverse polarity
Supply voltage	14 ... 30 V
Process variable*	pH, ORP, or temperature
Characteristic	Linear
Overrange*	22 mA in the case of error messages
Output filter*	PT, filter, time constant 0 ... 120 s
Measurement error ¹⁾	< 0.25 % current value + 0.05 mA
Start/end of scale*	Configurable within the measurement ranges for pH, mV, °C, °F
Min. span	pH 2.00 / 200 mV / 20 K / 36 °F
Real-time clock	Different time and date formats selectable
Power reserve	> 5 days
Display	LC display, 7-segment with icons
Main display	Character height approx. 22 mm, unit symbols approx. 14 mm
Secondary display	Character height approx. 10 mm
Text line	14 characters, 14 segments
Sensoface	3 status indicators (friendly, neutral, sad face)
Mode indicators	meas, cal, conf, diag Further icons for configuration and messages
Alarm indication	Red backlighting in case of alarm
Keypad	Keys: meas, info, 4 cursor keys, enter
HART communication	HART Version 6 Digital communication by FSK modulation of output current 1 Device identification, measured values, status and messages, parameter setting, calibration, records
IrDA interface	Infrared interface for transmission of records and logbook, parameter setting, calibration, firmware update
FDA 21 CFR Part 11	Access control by editable passcodes Logbook entry and flag via HART in the case of configuration changes Message and logbook entry when enclosure is opened

Specifications

Diagnostics Functions

Calibration data	Calibration date, zero, slope, response time
Device self-test	Displaytest, automatic memory test (RAM, FLASH, EEPROM), module test
Logbook	100 events with date and time
Extended logbook (TAN)	AuditTrail: 200 events with date and time

Service functions

Sensor monitor	Display of direct sensor signals (mV/temperature/resistance ...)
Current source	Current specifiable for output 1 and 2 (00.00 ... 22.00 mA)
IrDA	Activating the IrDA function
Passcodes	Assigning passcodes for menu access
Factory setting	Resetting all parameters to factory setting Exception: Calibration data
TAN	Enabling optionally available additional functions

Data retention	Parameters, calibration data, logbook > 10 years (EEPROM)
-----------------------	---

EMC	EN 61326-1 (General Requirements)
------------	-----------------------------------

Emitted interference	Class B (residential area)
----------------------	----------------------------

Immunity to interference	Industry EN 61326-2-3 (Particular Requirements for Transmitters)
--------------------------	---

Explosion protection

Stratos Pro A201X/A211X MSPH
(coming soon)

Europe:	ATEX Zone 0,1,2
USA:	FM Cl I Div 1,2 / Zone 0,1,2
Canada:	CSA Cl I Div 1,2 / Zone 0,1,2
International:	IECEX

Nominal operating conditions

Ambient temperature	-20 ... +65 °C
Transport/Storage temperature	-20 ... +70 °C
Relative humidity	10 ... 95% not condensing
Supply voltage	14 ... 30 V

Enclosure	Molded enclosure made of PBT/PC, glass reinforced
Fastening	Wall, pipe/post, or panel mounting
Color	Gray, RAL 7001
Ingress protection	IP 67
Flammability	UL 94 V-0
Dimensions	148 mm x 148 mm
Control panel cutout	138 mm x 138 mm to DIN 43 700
Weight	1.2 kg (1.6 kg incl. accessories and packaging)
Cable glands	3 knockouts for M20 x 1.5 cable glands 2 knockouts for NPT ½" or rigid metallic conduit
Connections	Terminals, conductor cross section max. 2.5 mm ²

* User-defined

- 1) Acc. to EN 60746-1, at nominal operating conditions
- 2) ± 1 count
- 3) Plus sensor error
- 4) At room temperature

- 00- Knick technical buffers (correspond to
- 01- Mettler-Toledo technical buffers)

°C	pH			
0	2.03	4.01	7.12	9.52
5	2.02	4.01	7.09	9.45
10	2.01	4.00	7.06	9.38
15	2.00	4.00	7.04	9.32
20	2.00	4.00	7.02	9.26
25	2.00	4.01	7.00	9.21
30	1.99	4.01	6.99	9.16
35	1.99	4.02	6.98	9.11
40	1.98	4.03	6.97	9.06
45	1.98	4.04	6.97	9.03
50	1.98	4.06	6.97	8.99
55	1.98	4.08	6.98	8.96
60	1.98	4.10	6.98	8.93
65	1.99	4.13	6.99	8.90
70	1.99	4.16	7.00	8.88
75	2.00	4.19	7.02	8.85
80	2.00	4.22	7.04	8.83
85	2.00	4.26	7.06	8.81
90	2.00	4.30	7.09	8.79
95	2.00	4.35	7.12	8.77

Buffer Tables

-02- Merck Titrisols, Riedel-de-Haen Fixanals

°C	pH				
0	2.01	4.05	7.13	9.24	12.58
5	2.01	4.04	7.07	9.16	12.41
10	2.01	4.02	7.05	9.11	12.26
15	2.00	4.01	7.02	9.05	12.10
20	2.00	4.00	7.00	9.00	12.00
25	2.00	4.01	6.98	8.95	11.88
30	2.00	4.01	6.98	8.91	11.72
35	2.00	4.01	6.96	8.88	11.67
40	2.00	4.01	6.95	8.85	11.54
45	2.00	4.01	6.95	8.82	11.44
50	2.00	4.00	6.95	8.79	11.33
55	2.00	4.00	6.95	8.76	11.19
60	2.00	4.00	6.96	8.73	11.04
65	2.00	4.00	6.96	8.72	10.97
70	2.01	4.00	6.96	8.70	10.90
75	2.01	4.00	6.96	8.68	10.80
80	2.01	4.00	6.97	8.66	10.70
85	2.01	4.00	6.98	8.65	10.59
90	2.01	4.00	7.00	8.64	10.48
95	2.01	4.00	7.02	8.64	10.37

-03- Ciba (94) buffers

Nominal values: 2.06 4.00 7.00 10.00

°C	pH			
0	2.04	4.00	7.10	10.30
5	2.09	4.02	7.08	10.21
10	2.07	4.00	7.05	10.14
15	2.08	4.00	7.02	10.06
20	2.09	4.01	6.98	9.99
25	2.08	4.02	6.98	9.95
30	2.06	4.00	6.96	9.89
35	2.06	4.01	6.95	9.85
40	2.07	4.02	6.94	9.81
45	2.06	4.03	6.93	9.77
50	2.06	4.04	6.93	9.73
55	2.05	4.05	6.91	9.68
60	2.08	4.10	6.93	9.66
65	2.07*	4.10*	6.92*	9.61*
70	2.07	4.11	6.92	9.57
75	2.04*	4.13*	6.92*	9.54*
80	2.02	4.15	6.93	9.52
85	2.03*	4.17*	6.95*	9.47*
90	2.04	4.20	6.97	9.43
95	2.05*	4.22*	6.99*	9.38*

* extrapolated

Buffer Tables

-04- NIST technical buffers

°C	pH				
0	1.67	4.00	7.115	10.32	13.42
5	1.67	4.00	7.085	10.25	13.21
10	1.67	4.00	7.06	10.18	13.01
15	1.67	4.00	7.04	10.12	12.80
20	1.675	4.00	7.015	10.06	12.64
25	1.68	4.005	7.00	10.01	12.46
30	1.68	4.015	6.985	9.97	12.30
35	1.69	4.025	6.98	9.93	12.13
40	1.69	4.03	6.975	9.89	11.99
45	1.70	4.045	6.975	9.86	11.84
50	1.705	4.06	6.97	9.83	11.71
55	1.715	4.075	6.97	9.83*	11.57
60	1.72	4.085	6.97	9.83*	11.45
65	1.73	4.10	6.98	9.83*	11.45*
70	1.74	4.13	6.99	9.83*	11.45*
75	1.75	4.14	7.01	9.83*	11.45*
80	1.765	4.16	7.03	9.83*	11.45*
85	1.78	4.18	7.05	9.83*	11.45*
90	1.79	4.21	7.08	9.83*	11.45*
95	1.805	4.23	7.11	9.83*	11.45*

* Values complemented

-05- NIST standard buffers
NIST Standard (DIN 19266 : 2000-01)

°C	pH			
0				
5	1.668	4.004	6.950	9.392
10	1.670	4.001	6.922	9.331
15	1.672	4.001	6.900	9.277
20	1.676	4.003	6.880	9.228
25	1.680	4.008	6.865	9.184
30	1.685	4.015	6.853	9.144
37	1.694	4.028	6.841	9.095
40	1.697	4.036	6.837	9.076
45	1.704	4.049	6.834	9.046
50	1.712	4.064	6.833	9.018
55	1.715	4.075	6.834	9.985
60	1.723	4.091	6.836	8.962
70	1.743	4.126	6.845	8.921
80	1.766	4.164	6.859	8.885
90	1.792	4.205	6.877	8.850
95	1.806	4.227	6.886	8.833

Please note:

The actual pH values of the individual batches of the reference materials are documented in a certificate of an accredited laboratory. This certificate is supplied with the respective buffers. Only these pH(S) values shall be used as standard values for the secondary reference buffer materials. Correspondingly, this standard does not include a table with standard pH values for practical use. The table above only provides examples of pH(PS) values for orientation.

Buffer Tables

-06- HACH buffers

Nominal values: 4.01 7.000 10.01 (± 0.02 at 25 °C)

°C	pH		
0	4.00	7.118	10.30
5	4.00	7.087	10.23
10	4.00	7.059	10.17
15	4.00	7.036	10.11
20	4.00	7.016	10.05
25	4.01	7.000	10.01
30	4.01	6.987	9.96
35	4.02	6.977	9.92
40	4.03	6.970	9.88
45	4.05	6.965	9.85
50	4.06	6.964	9.82
55	4.07	6.965	9.79
60	4.09	6.968	9.76
65	4.10*	6.98*	9.71*
70	4.12*	7.00*	9.66*
75	4.14*	7.02*	9.63*
80	4.16*	7.04*	9.59*
85	4.18*	7.06*	9.56*
90	4.21*	7.09*	9.52*
95	4.24*	7.12*	9.48*

* Values complemented

-07- WTW technical buffers

°C	pH			
0	2.03	4.01	7.12	10.65
5	2.02	4.01	7.09	10.52
10	2.01	4.00	7.06	10.39
15	2.00	4.00	7.04	10.26
20	2.00	4.00	7.02	10.13
25	2.00	4.01	7.00	10.00
30	1.99	4.01	6.99	9.87
35	1.99	4.02	6.98	9.74
40	1.98	4.03	6.97	9.61
45	1.98	4.04	6.97	9.48
50	1.98	4.06	6.97	9.35
55	1.98	4.08	6.98	
60	1.98	4.10	6.98	
65	1.99	4.13	6.99	
70	2.00	4.16	7.00	
75	2.00	4.19	7.02	
80	2.00	4.22	7.04	
85	2.00	4.26	7.06	
90	2.00	4.30	7.09	
95	2.00	4.35	7.12	

Buffer Tables

-08- Hamilton Duracal buffers

°C	pH		
0	4.01	7.12	10.23
5	4.01	7.09	10.19
10	4.00	7.06	10.15
15	4.00	7.04	10.11
20	4.00	7.02	10.06
25	4.01	7.00	10.01
30	4.01	6.99	9.97
35	4.02	6.98	9.92
40	4.03	6.97	9.86
45	4.04	6.97	9.83
50	4.05	6.97	9.79
55	4.06	6.98	9.75
60	4.08	6.98	9.72
65	4.10*	6.99*	9.69*
70	4.12*	7.00*	9.66*
75	4.14*	7.02*	9.59*
80	4.16*	7.04*	9.59*
85	4.18*	7.06*	9.56*
90	4.21*	7.09*	9.52*
95	4.24*	7.12*	9.48*

* Values complemented

-09- Reagecon buffers

°C	pH				
0°C	*2.01	*4.01	*7.07	*9.18	*12.54
5°C	*2.01	*4.01	*7.07	*9.18	*12.54
10°C	2.01	4.00	7.07	9.18	12.54
15°C	2.01	4.00	7.04	9.12	12.36
20°C	2.01	4.00	7.02	9.06	12.17
25°C	2.00	4.00	7.00	9.00	12.00
30°C	1.99	4.01	6.99	8.95	11.81
35°C	2.00	4.02	6.98	8.90	11.63
40°C	2.01	4.03	6.97	8.86	11.47
45°C	2.01	4.04	6.97	8.83	11.39
50°C	2.00	4.05	6.96	8.79	11.30
55°C	2.00	4.07	6.96	8.77	11.13
60°C	2.00	4.08	6.96	8.74	10.95
65°C	*2.00	*4.10	*6.99	*8.70	*10.95
70°C	*2.00	*4.12	*7.00	*8.67	*10.95
75°C	*2.00	*4.14	*7.02	*8.64	*10.95
80°C	*2.00	*4.16	*7.04	*8.62	*10.95
85°C	*2.00	*4.18	*7.06	*8.60	*10.95
90°C	*2.00	*4.21	*7.09	*8.58	*10.95
95°C	*2.00	*4.24	*7.12	*8.56	*10.95

* Values complemented

-U1- Specifiable Buffer Set

You can specify a buffer set with 2 buffer solutions in the temperature range of 0 ... 95 °C, step width: 5 °C.

To do so, select buffer set -U1- in the configuration menu.

As delivered, the Ingold technical buffer solutions pH 4.01 / 7.00 are stored as buffer set and can be edited.





Conditions for the specifiable buffer set:

- All values must lie in the range pH 0 ... 14
- Maximum difference between two adjacent pH values (5 °C step width) of the same buffer solution: pH 0.25
- The values of buffer solution 1 must be lower than those of buffer solution 2:
The difference between values for identical temperatures must be greater than 2 pH units.

Faulty entries are indicated in measuring mode by the "FAIL BUFFERSET -U1-" message.

The 25 °C value is always used for buffer display during calibration.

-U1- Specifiable Buffer Set

Step	Action/Display	Remark
Select buffer set -U1- (CONFIG / SNS menu)		
Select buffer solution 1 for editing	 <p>Select "YES" using up/down key.</p>	You are prompted for confirmation to prevent accidental changes of the settings.
Editing the values of buffer solution 1	 <p>Edit using arrow keys, press enter to confirm and proceed to next temperature value.</p> 	Enter the values for the first buffer solution in 5°C steps. The difference to the next value must not exceed 0.25 pH unit.
Select buffer solution 2 for editing		The difference between buffer solutions for identical temperatures must be greater than 2 pH units.

-U1- Specifiable Buffer Set

Buffer Set U1:

Fill in your configuration data or use the table as original for copy.

Temperature (°C)	Buffer 1	Buffer 2
5		
10		
15		
20		
25		
30		
35		
40		
45		
50		
55		
60		
65		
70		
75		
80		
85		
90		
95		

Alarm condition:

- The display backlighting turns **red**
 - The alarm icon  is displayed
 - The complete measured-value display blinks
 - „**ERR xxx**“ is displayed in the lower menu line
- Press the [**info**] key to view a short error text:
- The error text appears in the lower menu line
 - The main display reads “**InFo**”.

Parameter errors:

Configuration data such as current range, limit values, etc are checked during the input.

If they are out of range,

- “**ERR xxx**“ is displayed for 3 sec,
- the display backlighting flashes red,
- the respective maximum or minimum value is shown,
- input must be repeated.

If a faulty parameter arrives through the interface (IrDA, HART),

- an error message will be displayed: “**ERR 100...199**“
- the faulty parameter can be localized by pressing the [**info**] key

Calibration errors:

If errors occur during calibration, e.g. by using a wrong calibration solution,

- an error message will be displayed
- calibration will be restarted

Sensoface:

If the Sensoface becomes sad,

- the display backlighting will turn purple
- the cause can be seen by pressing the **info** key
- the calibration data can be seen in the Diagnostics menu

Error Messages

Error	Info text (is displayed in case of fault when the Info key is pressed)	Problem Possible causes
ERR 99	DEVICE FAILURE	Error in factory settings EEPROM or RAM defective This error message only occurs in the case of a total defect. The device must be repaired and recalibrated at the factory.
ERR 98	CONFIGURATION ERROR	Error in configuration or calibration data Configuration or calibration data defective Reset device to factory settings (SERVICE/DEFAULT), then calibrate
ERR 97	NO MODULE INSTALLED	No module (Not for digital devices) Please have the module installed in the factory.
ERR 96	WRONG MODULE	Wrong module Please have the module replaced in the factory.
ERR 95	SYSTEM ERROR	System error Restart required. If error still persists, send in the device for repair.
ERR 01	NO SENSOR	pH sensor * Sensor defective Sensor not connected Break in sensor cable
ERR 02	WRONG SENSOR	Wrong sensor *
ERR 03	CANCELED SENSOR	Sensor devaluated *

Error	Info text (is displayed in case of fault when the Info key is pressed)	Problem Possible causes
ERR 04	SENSOR FAILURE	Failure in sensor *
ERR 05	CAL DATA	Error in cal data *
ERR 10	ORP RANGE	ORP display range violation < -1999 mV or > 1999 mV
ERR 11	PH RANGE	pH display range violation < -2 or > 16
ERR 12	MV RANGE	mV range
ERR 13	TEMPERATURE RANGE	Temperature range violation
ERR 15	SENSOCHECK GLASS-EL	Sensocheck glass
ERR 16	SENSOCHECK REF-EL	Sensocheck ref.
ERR 60	OUTPUT LOAD	Load error
ERR 61	OUTPUT 1 TOO LOW	Output current 1 < 3.8 mA
ERR 62	OUTPUT 1 TOO HIGH	Output current 1 > 20.5 mA
ERR 63	OUTPUT 2 TOO LOW	Output current 2 < 3.8 mA
ERR 64	OUTPUT 2 TOO HIGH	Output current 2 > 20.5 mA
ERR 69	TEMP. OUTSIDE TABLE	Temperature value outside table
ERR 100	INVALID SPAN OUT1	Configuration error Output range 1
ERR 101	INVALID SPAN OUT2	Configuration error Output range 2

Error Messages

Error	Info text (is displayed in case of fault when the Info key is pressed)	Problem Possible causes
ERR 102	FAILURE BUFFERSET -U1-	Configuration error Specifiable buffer set U1
ERR 104	INVALID PARAMETER CONTROLLER	Configuration error Controller
ERR 105	INVALID SPAN I-INPUT	Configuration error Current input
ERR 106 ...255	VOID PARAMETER	Invalid parameter

*) Digital sensors (ISM, InduCon, Memosens)

(Sensochek must have been activated during configuration.)

The smiley in the display (Sensoface) alerts to sensor problems (defective sensor, sensor wear, defective cable, maintenance request). The permitted calibration ranges and the conditions for a friendly, neutral, or sad Sensoface are summarized in the following table. Additional icons refer to the error cause.

Sensochek

Continuously monitors the sensor and its wiring.

Critical values make the Sensoface “sad” and the corresponding icon blinks:



The Sensochek message is also output as error message Err 15 (glass electrode) or Err 16 (reference electrode – for digital transmitters, however only with InduCon sensors with SG). The alarm contact is active, the display backlighting turns red, output current 1 is set to 22 mA (when configured correspondingly).











Sensochek can be switched off during configuration (then Sensoface is also disabled).



Exception:

After a calibration a smiley is always displayed for confirmation.



Please note:

The worsening of a Sensoface criterion leads to the devaluation of the Sensoface indicator (Smiley becomes “sad”). An improvement of the Sensoface indicator can only take place after calibration or removal of the sensor defect.

Display	Problem	Status
	Asymmetry potential and slope	 Asymmetry potential (zero) and slope of the sensor are still okay. The sensor should be replaced soon.
		 Asymmetry potential and slope of the sensor have reached values which no longer ensure proper calibration. Replace sensor.
	Calibration timer	 Over 80% of the calibration interval has already past.
		 The calibration interval has been exceeded.
	Sensor defect	 Check the sensor and its connections (see also Error Messages Err 15 and Err 16).
	Response time	 Sensor response time has increased. The sensor should be replaced soon. To achieve an improvement, clean the sensor and soak it in buffer.
		 Sensor response time significantly increased (> 72 s, calibration aborted after 120 s) Replace sensor.

Display	Problem	Status
	Sensor wear (for digital sensors only)	<p data-bbox="456 176 948 336">  High temperatures and pH values have caused a wear of over 80%. The sensor should be replaced soon. </p> <p data-bbox="456 380 948 438">  Wear is at 100%. Replace sensor. </p>

EC Declaration of Conformity

		Knick > Knick Elektronische Messgeräte GmbH & Co. KG Beuckestr. 22 D-14163 Berlin
EG-Konformitätserklärung EC Declaration of Conformity Déclaration de Conformité CE		
Dokument-Nr. / Document No. / No. document	EG80724A	Aufbewahrung / Keeping / Gardé en dépôt Jürgen Gammin (KB)
Wir, die / We, / Nous,	Knick Elektronische Messgeräte GmbH & Co. KG Beuckestr. 22, D-14163 Berlin	
	erklären in alleiniger Verantwortung, daß dieses Produkt / diese Produkte, declare under our sole responsibility that the product / products, déclarons sous notre seule responsabilité que le produit / les produits,	
Produktbezeichnung / Product identification / Désignation du produit	Stratos® Pro Typen A20*N-*, A21*N-*	
auf welche(s) sich diese Erklärung bezieht, mit allen wesentlichen Anforderungen der folgenden Richtlinien des Rates übereinstimmen: to which this declaration relates is/are in conformity with all essential requirements of the Council Directives relating to: auquel/auxquels se réfère cette déclaration est/sont conforme(s) aux exigences essentielles de la Directives du Conseil relatives à: *)		
Niederspannungs-Richtlinie / Low-voltage directive / Directive basse tension Harmonisierte Normen / Harmonised Standards / Normes harmonisées	2006/95/EG DIN EN 61010-1 / VDE 0411 Teil 1: 2002-08	Jahr der Anbringung der CE-Kennzeichnung / Year in which the CE marking was affixed / L'année d'apposition du marquage CE 2008
EMV-Richtlinie / EMC directive / Directive CEM Norm / Standard / Norme	2004/108/EG DIN EN 61326-1 / VDE 0843 Teil 20-1: 2006-10 DIN EN 61326-2-3 / VDE 0843 Teil 20-2-3: 2007-05	
*) Die Sicherheitsanweisungen der mitgelieferten Produktokumentation sind zu beachten. Bei einer mit dem Hersteller nicht abgestimmten Änderung des Gerätes und/oder bei Nichtbeachtung der Sicherheitsanweisungen verliert diese Erklärung ihre Gültigkeit. The safety instructions contained in the documentation accompanying the product have to be observed. If the apparatus is modified without having obtained manufacturer's prior consent and/or the safety instructions are not followed, this declaration becomes void. Il est impératif de respecter les instructions de sécurité dans la documentation fournie avec le produit. En cas de modification de l'appareil sans l'accord du fabricant et/ou en cas de non-respect des instructions de sécurité, cette déclaration perd sa vigueur.		
Ausstellungsort, -datum / Place and date of issue / Lieu et date d'émission	Berlin, 24.07.2008	
	Knick Elektronische Messgeräte GmbH & Co. KG	
	 ppa. Wolfgang Feucht (Vice President Engineering, R&D)	 ppa. Bernhard Kusig (Vice President Marketing/Sales)

		 Knick Elektronische Messgeräte GmbH & Co. KG Beuckestr. 22 D-14163 Berlin
EG-Konformitätserklärung EC Declaration of Conformity Déclaration de Conformité CE		
Dokument-Nr. / Document No. / No. document	EG80724B	Aufbewahrung / Keeping / Garde en dépôt Jürgen Cammin (KB)
Wir, die / We, / Nous,	Knick Elektronische Messgeräte GmbH & Co. KG Beuckestr. 22, D-14163 Berlin	
Produktbezeichnung / Product identification / Désignation du produit	erklären in alleiniger Verantwortung, daß dieses Produkt / diese Produkte, declare under our sole responsibility that the product / products, déclarons sous notre seule responsabilité que le produit / les produits,	
	Stratos® Pro Typen A21*X-*	
auf welche(s) sich diese Erklärung bezieht, mit allen wesentlichen Anforderungen der folgenden Richtlinien des Rates übereinstimmen: to which this declaration relates is/are in conformity with all essential requirements of the Council Directives relating to: auquel/auxquels se réfère cette déclaration est/sont conforme(s) aux exigences essentielles de la Directives du Conseil relatives à: *)		
ATEX 100 Richtlinie / ATEX 100 directive / Directive ATEX 100	94/9/EG EN 60079-0: 2006 EN 60079-11: 2007 EN 60079-26: 2007 EN 61241-0: 2006 EN 61241-11: 2006	EG-Baumusterprüfbescheinigung / EC Type Examination Certificate / Attestation d'examen CE de type KEMA Quality B.V., NL-6812 AR Arnhem, ExNB-No. 0344 KEMA 08 ATEX 0100 Kennzeichnung / Designation / Marquage C E 0044 II 2(1) G Ex Ib [Ia] IIC T4 oder/or/ou II 1 G Ex Ia IIC T4 oder/or/ou II 1 D Ex IaD 20 IP6x T85 °C oder/or/ou II 2 D Ex IaD 21 IP6x T85 °C
Harmonisierte Normen / Harmonised Standards / Normes harmonisées		
Niederspannungs-Richtlinie / Low-voltage directive / Directive basse tension	2006/95/EG DIN EN 61010-1 / VDE 0411 Teil 1: 2002-08	Jahr der Anbringung der CE-Kennzeichnung / 2008 Year in which the CE marking was affixed / L'année d'apposition du marquage CE
Harmonisierte Normen / Harmonised Standards / Normes harmonisées		
EMV-Richtlinie / EMC directive / Directive CEM	2004/108/EG DIN EN 61326-1 / VDE 0843 Teil 20-1: 2006-10 DIN EN 61326-2-3 / VDE 0843 Teil 20-2-3: 2007-05	
Norm / Standard / Norme		
Ausstellungsort, -datum / Place and date of issue / Lieu et date d'émission	Berlin, 24.07.2008 Knick Elektronische Messgeräte GmbH & Co. KG	
	 ppa. Wolfgang Feucht (Vice President Engineering, R&D)	 ppa. Bernhard Kusig (Vice President Marketing/Sales)

*) Die Sicherheitsanweise der mitgelieferten Produktdokumentation sind zu beachten. Bei einer mit dem Hersteller nicht abgestimmten Änderung des Gerätes und/oder bei Nichtbeachtung der Sicherheitsanweise verliert diese Erklärung ihre Gültigkeit.
 The safety instructions contained in the documentation accompanying the product have to be observed. If the apparatus is modified without having obtained manufacturer's prior consent and/or the safety instructions are not followed, this declaration becomes void.
 Il est impératif de respecter les instructions de sécurité dans la documentation fournie avec le produit. En cas de modification de l'appareil sans l'accord du fabricant et/ou en cas de non-respect des instructions de sécurité, cette déclaration perd sa vigueur.

Conformity with FDA 21 CFR Part 11

In their directive “Title 21 Code of Federal Regulations, 21 CFR Part 11, Electronic Records; Electronic Signatures” the US American health agency FDA (Food and Drug Administration) regulates the production and processing of electronic documents for pharmaceutical development and production. This results in requirements for measuring devices used for corresponding applications. The following features ensure that the measuring devices of the M420 Series meet the demands of FDA 21 CFR Part 11:

Electronic Signature – Passcodes

Access to the device functions is regulated and limited by individually adjustable codes – “Passcodes” (see SERVICE). This prevents unauthorized modification of device settings or manipulation of the measurement results. Appropriate use of these passcodes makes them suitable as electronic signature.

Audit Trail

Every (manual) change of device settings can be automatically documented. Each change is tagged with a “Configuration Change Flag”, which can be interrogated and documented using HART communication. Altered device settings or parameters can also be retrieved and documented using HART communication.

Extended logbook

Audit Trail also records function activations (CAL, CONFIG, SERVICE), some Sensoface messages (cal timer, wear), and opening of the enclosure.

Index

A

- Access codes 87, 121, 132
- Accessories 89
- Alarm 29
 - Alarm delay 56
- Ambulance TAN 87
- Application in hazardous locations 15
- Approvals for application in hazardous locations 9, 94
- Assembly 11
- Asymmetry potential 73
- Audit Trail 83, 121
- Automatic calibration (Calimatic) 68

B

- Backlighting 23
- Buffer tables 97

C

- Calibration 26, 64
 - Automatic calibration (Calimatic) 68
 - Calibration error 109
 - Calibration timer 43, 114
 - Configuration 40
 - Data entry of premeasured sensors 72
 - ISFET sensors 64
 - Manual calibration with buffer entry 70
 - Product calibration (pH) 74
 - Redox calibration 76
 - Temperature probe adjustment 78
 - Zero adjustment 67
- Calibration data 81
- Calibration error 109
- Calibration mode 41, 65
- Calimatic 68
- CD-ROM 3
- CIP 45
- Cleaning cycles 45
- Commissioning 8

- Compulsory marking 9, 16
- Configuration 26
 - Alarm 56
 - Calibration mode 40
 - Calibration timer 42
 - Cleaning cycles 44
 - Current output 1 46
 - Current output 2 52
 - Individual configuration data 36, 108
 - Menu groups 31
 - Menu structure 30
 - Output current during Error and HOLD 50
 - Overview 33
 - Sensocheck 56
 - Sensor 38
 - Sterilization cycles 44
 - Tag number 58
 - Temperature 38
 - Time and date 58
 - Time constant of output filter 48
- Connection examples 19
- Connection to supply units 90
- Control Drawings 118
- Converting Slope to mV 73
- CSA Control Drawings 120

D

- Data entry of premeasured sensors 72
- Date 59
 - Display 79
- Device self-test 82
- Device type, display 84
- Diagnostics 26, 80
 - Calibration data 81
 - Device self-test 82
 - Logbook 83
 - Sensor data 81

- Sensor monitor 84
 - Version 84
- Digital sensors 60
 - Sensor type selection 39
- Dimensions 12
- Display 23
 - Display test 82
- Display backlighting 23
- Disposal 2
- Documentation 3

E

- EC Declaration of Conformity 116
- EEPROM test 82
- Electronic Signature 121
- Enclosure 12
- Enclosure components 11
- Entering values 25
- Error handling 109
- Error messages 110
- Explosion protection 94
- Extended logbook 83, 121
- External temperature measurement 55

F

- FDA 21 CFR Part 11 121
- FLASH test 82
- FM Control Drawings 119

H

- HOLD 26, 28
 - End 28
 - External activation of HOLD 29
 - Manual activation of HOLD 29
 - Output signal during HOLD 28, 51
 - Output signal response 28

I

- Info text 110
- Installation 15
 - Hazardous locations 9
- Intended use 7
- Introduction 7
- IrDA communication 87

K

- Keypad 22

L

- Logbook 83

M

- Manual calibration with buffer entry 70
- Measured values, display 84
- Measurement 79
- Measuring 24
- Memosens 60
 - Connection 61
 - Sensor replacement 62
 - Wiring example 21
- Menu structure 27
 - Configuration 30
- Module test 82
- Mounting plan 12

O

- Operating modes 26
- Operating mode, selection 25
- Operating states 88
- Options 87, 89
- Order code 89
- ORP calibration 76
- Output current, fixed value 86
- Output current range 46, 52

Output filter 48
Output signal during HOLD 28, 51
Overview 10

P

Package contents 3, 11
Panel mounting 14
Parameter error 109
Parameter set A/B 31
 Display 79
 Individual configuration data 36
 Manual selection 32
Passcodes 121, 132
 Assigning passcodes 87
Pipe mounting 13
Point of measurement (TAG) 59
Power supply units 90
Presetting pH calibration 65
Process variable 47, 53
Product calibration 74
Product line 89
Protective hood 13

R

RAM test 82
Rating plates 16
Redox calibration 76
Registered trademarks 131
Release of options 87
Reset to factory settings 87
Return of products under warranty 2

S

Safety information 8
Safety instructions 3
Selection menu 25
Sensocheck 56, 113
 Configuration 57
Sensoface 109, 113

- Sensor connection 17, 19
- Sensor data, display 81
- Sensor defect 114
- Sensor monitor 84, 86
- Sensor type selection 38
- Sensor wear 115
- Serial number, display 84
- Service 26, 85
 - Factory setting 87
 - IrDA communication 87
 - Passcodes 87
 - Releasing options 87
 - Sensor monitor 86
 - Specifying current outputs 86
- Service passcode lost 87
- Signal colors 23
- SIP 45
- Software version, display 84
- Specifications 91
- Start-up 8
- Sterilization cycles 45
- Supply units 90

T

- Tag number (TAG) 59
- TAN options 87, 89
- Temperature compensation 55
- Temperature dependence of reference systems measured against SHE 76
- Temperature detection 38
 - for calibration 41
 - Temp specification via current input 39, 55
- Temperature probe adjustment 78
- Terminal assignments 16
- Terminals 9, 15, 16
- Time 59
 - Display 79
- Time constant of output filter 49
- Trademarks 131

Index

U

User Interface 22

W

Warranty 2

Wiring 17

 Examples 19

 Power supply units 90

Z

Zero adjustment (ISFET) 66

Trademarks

The following names are registered trademarks. For practical reasons they are shown without trademark symbol in this manual.

Stratos®

Sensocheck®

Sensoface®

Calimatic®

GainCheck®

InPro® is a registered trademark of Mettler-Toledo.

Memosens® is a registered trademark of Endress+Hauser Conducta GmbH and Knick Elektronische Meßgeräte GmbH & Co. KG.

HART® is a registered trademark of the HART Communication Foundation.

Passcodes

In the SERVICE – CODES menu you can assign passcodes to protect the access to certain functions.

Operating mode	Passcode
Service (SERVICE)	5555
Diagnostics (DIAG)	
HOLD mode	
Calibration (CAL)	
Configuration (CONF)	

Knick Elektronische Messgeräte GmbH & Co. KG

P.O. Box 37 04 15
D-14134 Berlin

Tel: +49 (0)30 - 801 91 - 0
Fax: +49 (0)30 - 801 91 - 200
Internet: <http://www.knick.de>
knick@knick.de

